

ECOFLOW POWEROCEAN Home Solar Battery Solution

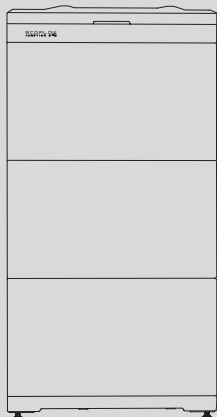

For the latest documents, please scan the QR code or visit:

Q <https://enterprise.ecoflow.com/eu/documentation>

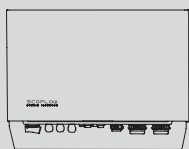



IMPORTANT

- Before installing, operating, and maintaining the equipment, read and follow up Installation Guide and Safety Instructions.

CONTENTS

- 1 **Safety Instructions**
- 2 **Preparing Tools and Instruments**
- 2 **What's In The Box**
- 4 **System Installation**
 - 4 Installation Environment Requirements
 - 5 Installation Space Requirements
 - 6 Installing Battery
 - 8 Installing Inverter
 - 8 Single EcoFlow PowerOcean System
 - 9 (Optional) EcoFlow PowerOcean System Cascading
 - 10 (Optional) Integrating Existing PV System to the EcoFlow PowerOcean System
 - 10 (Optional) Integrating SG-READY certified Heatpump or EV Charger to the EcoFlow PowerOcean System
- 11 **Electrical Connection**
 - 12 Single EcoFlow PowerOcean System Wiring Diagram
 - 13 EcoFlow PowerOcean System Cascading Wiring Diagram
 - 14 Connecting PE Cables
 - 14 Connecting PV Input Cables
 - 16 Connecting GRID Cables
 - 16 Connecting BACKUP Cables
 - 17 Connecting Battery Power Cables
 - 18 Connecting Battery Communication Cables
 - 19 (Optional) Cascading Batteries
 - 20 Installing COM Connector With Shorting Wire
 - 21 (Optional) Installing Emergency Stop (EPO)
 - 21 (Optional) Connecting Communication Cable of Smart Meter 2 from EcoFlow to the PowerOcean System
 - 22 (Optional) Connecting Communication Cable of EcoFlow PowerHeat/EcoFlow PowerPulse to the PowerOcean System
 - 22 (Optional) Connecting Communication Cable of SG-READY certified Heatpump from other brands to the PowerOcean System
 - 23 (Optional) Connecting Communication Cables between the two cascaded EF HD-P3-(6K0-12K)-S1
 - 24 Connecting Smart Meter
 - 24 Connecting to Internet
- 26 **System Commissioning**
 - 26 Checking before Power-On
 - 26 System Power-On
 - 26 System Power-Off
 - 26 LED Indicators
 - 27 System Commissioning
 - 32 How Users Add Devices

Safety Instructions

Symbol	Description
 DANGER	Indicates a hazard with a high level of risk which, if not avoided, will result in death or serious injury.
 CAUTION	Caution, risk of electric shock.
 WARNING	Indicates a hazard with a medium level of risk which, if not avoided, could result in death or serious injury.
 CAUTION	Indicates a hazard with a low level of risk which, if not avoided, could result in minor or moderate injury.
 NOTICE	Indicates a potentially hazardous situation which, if not avoided, could result in equipment damage, data loss, performance deterioration, or unanticipated results. NOTICE is used to address practices not related to personal injury.

 **DANGER**

- Before installing, operating, and maintaining the equipment, read and follow up Installation Guide and Safety Instructions.
- Personnel who plan to install or maintain EcoFlow equipment must receive thorough training, understand all necessary safety precautions, and be able to correctly perform all operations.
- Personnel who will install, operate, and maintain the equipment, including operators, trained personnel, and professionals, should possess the local national required qualifications in special operations such as high-voltage operations, working at heights, and operations of special equipment.
- Before connecting cables, ensure that the equipment is intact. Otherwise, electric shocks or fire may occur.
- Before installing, operating, and maintaining the equipment, **always disconnect it from all power.**
- Wear proper PPE (Personal protective equipment) before any operations.

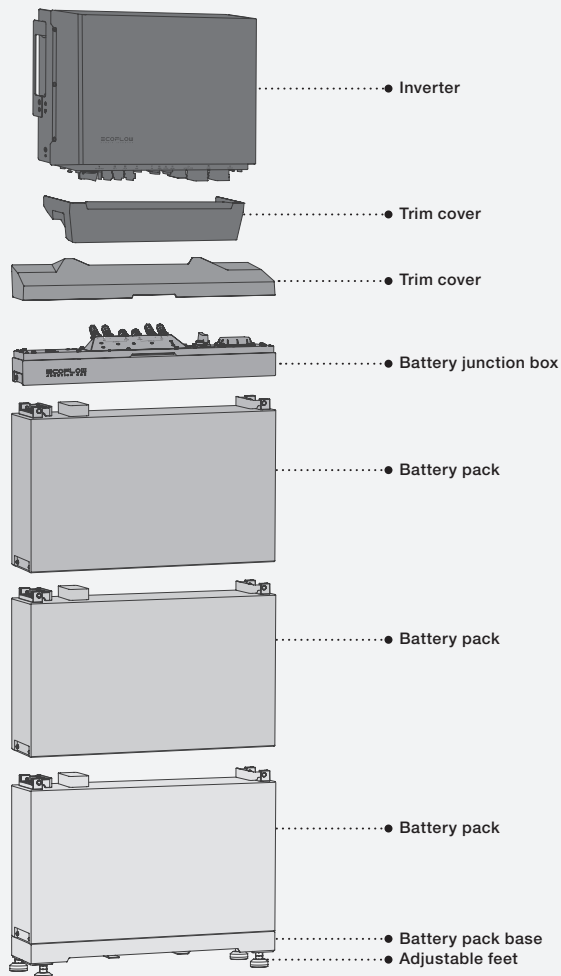

Preparing Tools and Instruments

• ESSENTIAL TOOLS

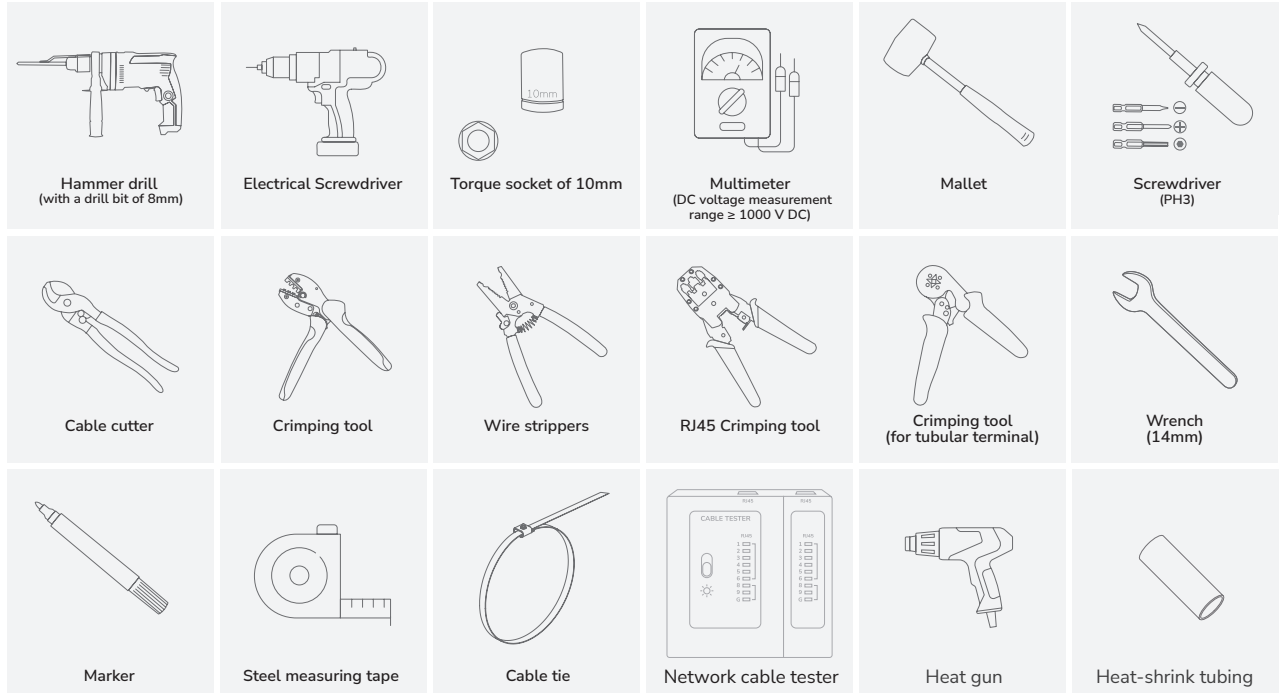

• OPTIONAL TOOLS

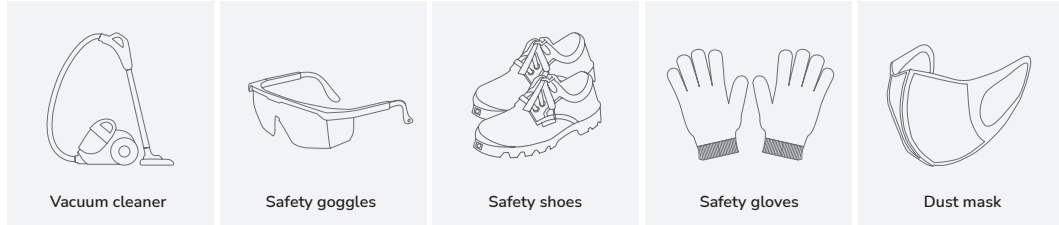









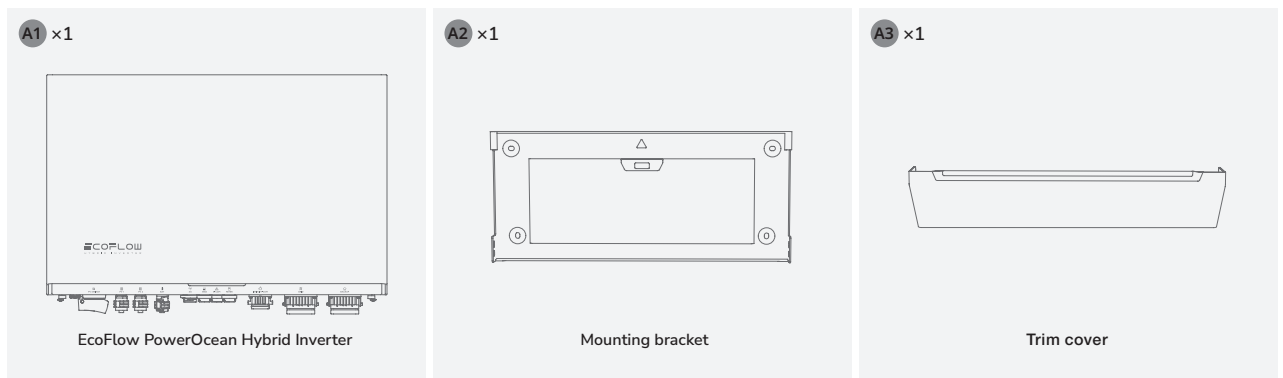

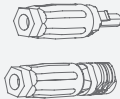
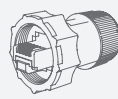
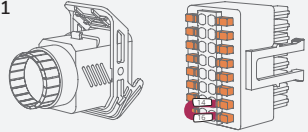
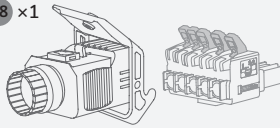
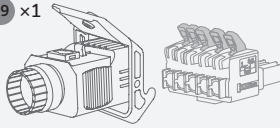

What's In The Box

NOTICE



- Before unpacking, check the outer packing for damage, such as holes and cracks, and check the equipment model. If any damage is found, do not unpack the package and contact the supplier as soon as possible.
- After unpacking, check that the deliverables are intact and complete. If any item is missing or damaged, contact the supplier.
- It is recommended to keep the original package for further needs.

• ECOFLOW POWEROCEAN HYBRID INVERTER BOX





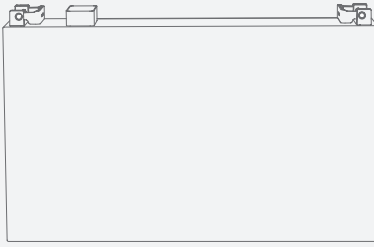
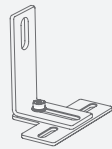





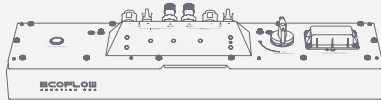

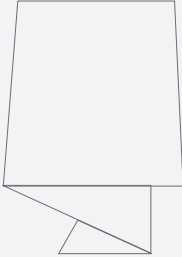

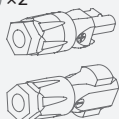
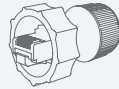
<p>A4 ×1</p>  <p>Smart meter (Either included or sold separately. The actual deliverables may vary.)</p>	<p>A5 ×2</p>  <p>PV terminals</p>	<p>A6 ×2</p>  <p>Communication terminal</p>	<p>A7 ×1</p>  <p>COM connector with shorting wire</p>		
<p>A8 ×1</p>  <p>Grid connector</p>	<p>A9 ×1</p>  <p>Backup connector</p>	<p>A10 ×4</p>  <p>Expansion bolt(M6*60)</p>	<p>A11 ×2</p>  <p>Screws(M5*12)</p>	<p>A12 ×1</p>  <p>Disassembly and Assembly Tool</p>	
<p>A13 ×2</p>  <p>OT terminal</p>	<p>A14 ×10</p>  <p>Tubular Terminal (For wire gauge 10AWG/6mm²)</p>	<p>A15 ×5</p>  <p>Tubular Terminal (For wire gauge 22AWG/0.5mm²)</p>	<p>A16 ×6</p>  <p>Tubular Terminal (For wire gauge 18AWG/1mm²)</p>	<p>A17 ×3</p>  <p>Tubular Terminal (For wire gauge 26AWG/0.25mm²)</p>	<p>A18 ×1</p>  <p>Marking-off template for inverter</p>

• ECOFLOW POWEROCEAN LFP BATTERY BOX

<p>B1 ×1</p>  <p>EcoFlow PowerOcean LFP Battery</p>	<p>B2 ×2</p>  <p>Battery T-shaped mounting piece(M6) Battery L-shaped mounting piece</p>
<p>A10 ×2</p>  <p>Expansion bolt(M6*60)</p>	<p>B3 ×8</p>  <p>Screws(M5*12)</p>

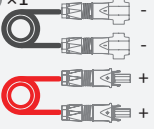
• ECOFLOW POWEROCEAN BATTERY JUNCTION BOX

<p>C1 ×1</p>  <p>Battery junction box</p>	<p>C3 ×1</p>  <p>Trim cover</p>	<p>C4 ×1</p>  <p>Marking-off template for battery</p>
<p>C2 ×1</p>  <p>Battery base</p>	<p>C5 ×2</p>  <p>Battery terminals</p>	<p>A6 ×2</p>  <p>Communication terminal</p>
<p>A10 ×2</p>  <p>Expansion bolt(M6*60)</p>	<p>B3 ×4</p>  <p>Screws(M5*12)</p>	<p>C6 ×4</p>  <p>Adjustable feet</p>
<p>A13 ×1</p>  <p>OT terminal</p>	<p>C7 ×1</p>  <p>Termination resistor</p>	<p>Some battery junction boxes (C1) already have termination resistors installed as delivered, while some do not. The actual deliverables may vary.</p>
<p>C8 ×1</p>  <p>Battery Power Cables (1.5m)</p>	<p>C9 ×1</p>  <p>Battery Communication Cable(1.5m)</p>	

System Installation

Installation Environment Requirements

WARNING

NOTICE

- The installation and use environment must meet relevant international, national, and local standards for lithium batteries, and are in accordance with the local laws and regulations.
- When installing the equipment in a garage, keep it away from the drive way.
- The mounting structure where the equipment is installed must be fire resistant. Do not install the equipment on flammable building materials.
- Ensure that the installation surface is solid enough to bear the weight of the equipment.

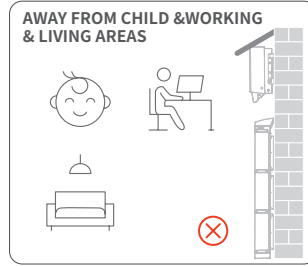
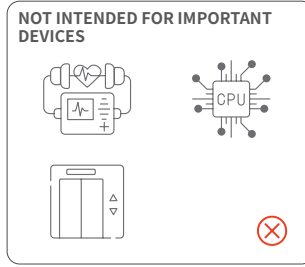
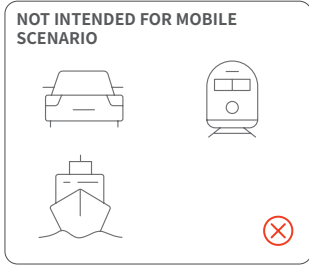
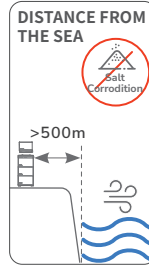
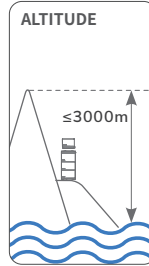
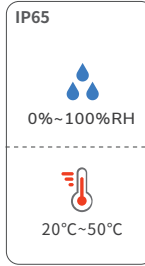
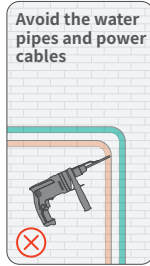
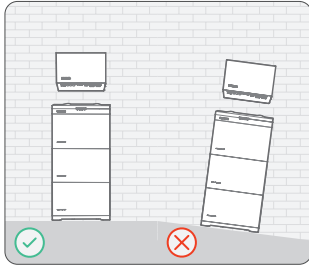
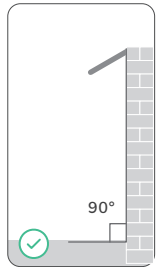
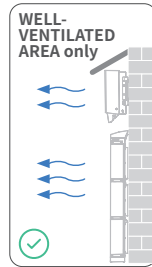
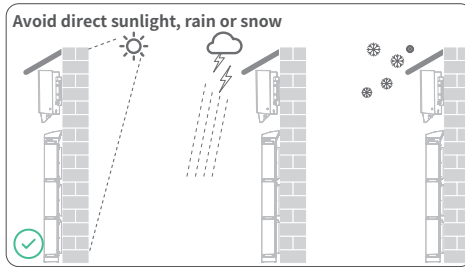
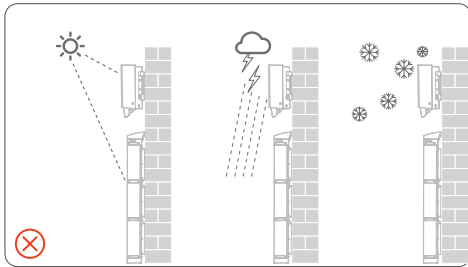

Installation Space Requirements



WARNING

- Reserve enough clearance around equipments to ensure sufficient space for installation and heat dissipation.

NOTICE

- Ensure there is enough space on both sides of the battery to facilitate the locking operation of the screws on the side of the battery.
- When installing two sets of batteries (number of battery packs ≥ 4), ensure that the minimum clearance between the two sets of batteries is 400mm, while greater clearance is also permitted if it is required by the specific local electrical codes.
- When installing multiple inverters, install them in horizontal mode if sufficient space is available and install them in triangle mode if no sufficient space is available. Stacked installation is not allowed.

• SINGLE ECOFLOW POWEROCEAN SYSTEM

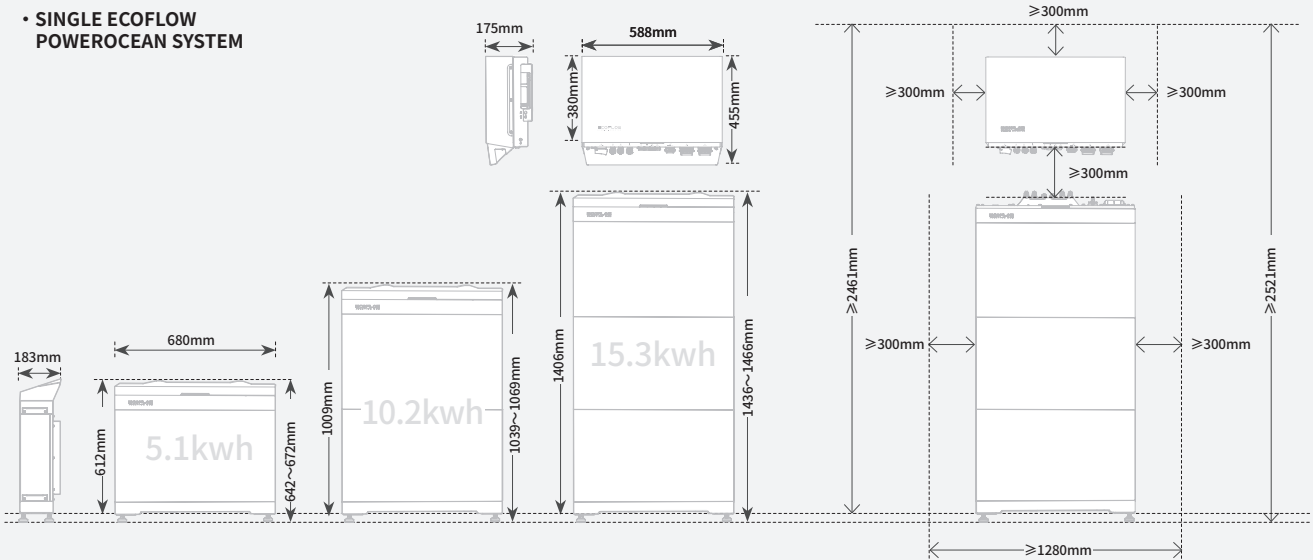

• ECOFLOW POWEROCEAN SYSTEM CASCADING

- HORIZONTAL INSTALLATION MODE (PREFERRED)

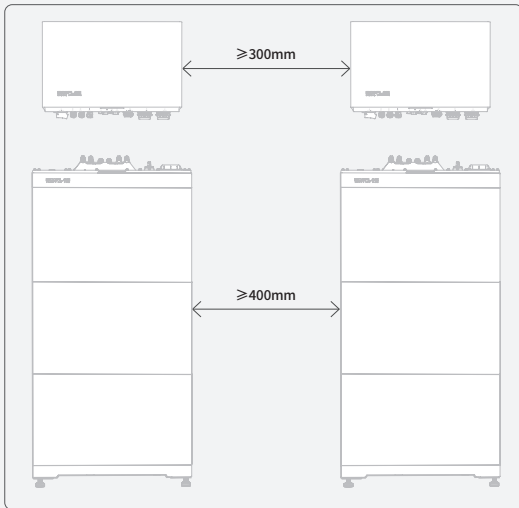

- SECOND INSTALLATION MODE (RECOMMENDED)

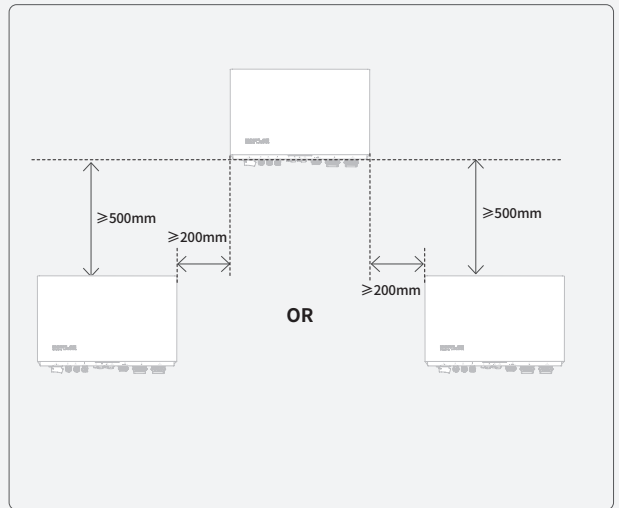

- STACKED INSTALLATION MODE (NOT ALLOWED)



Installing Battery

⚠ DANGER

- When drilling holes, avoid the water pipes and power cables buried in the wall and under the floor.
- When drilling holes, protect the battery base from shavings or dust.
- Before installing the battery, make sure that the click-on terminals on the top and bottom of the battery are free of foreign objects or any liquid.

⚠ CAUTION

- Assign enough personnel (two or more) to move battery to avoid personal injury and battery damage.
- When moving battery, hold handles on top of the battery module.

NOTICE

- Sealant is applied underneath the battery base to ensure its resistance against water.
- There will be a gap between the battery junction box and the battery pack before the screws are tightened. This gap is caused by the mechanical design to meet the IP rating, and will normalize after the screws are tightened.
- **(Optional) Install the provided adjustable feet to the base if needed.** Then you can adjust the feet and check the level on the base to ensure that the base is placed horizontally, screw the nuts of the four feet to the top to lock.

• WITH ADJUSTABLE FEET

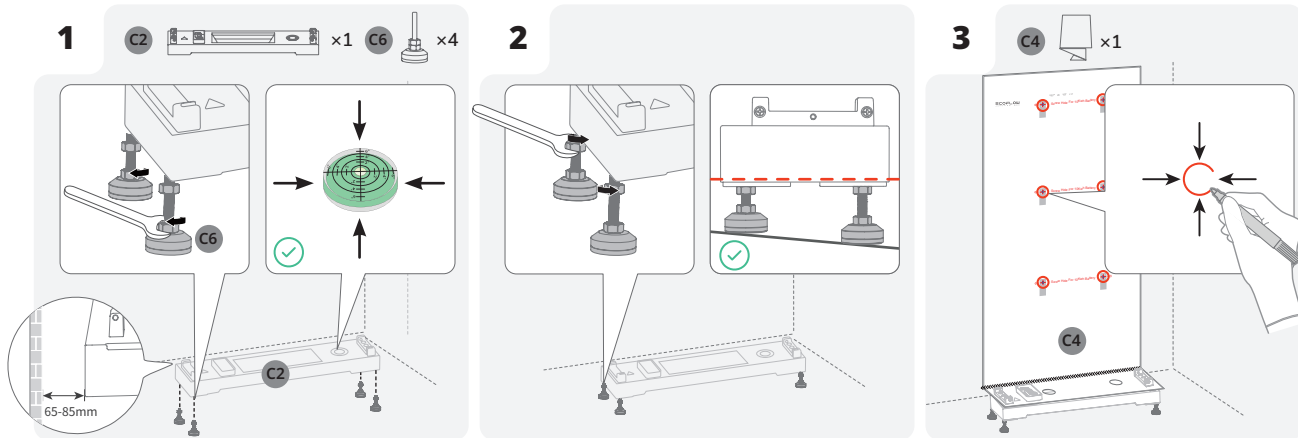

• WITHOUT ADJUSTABLE FEET

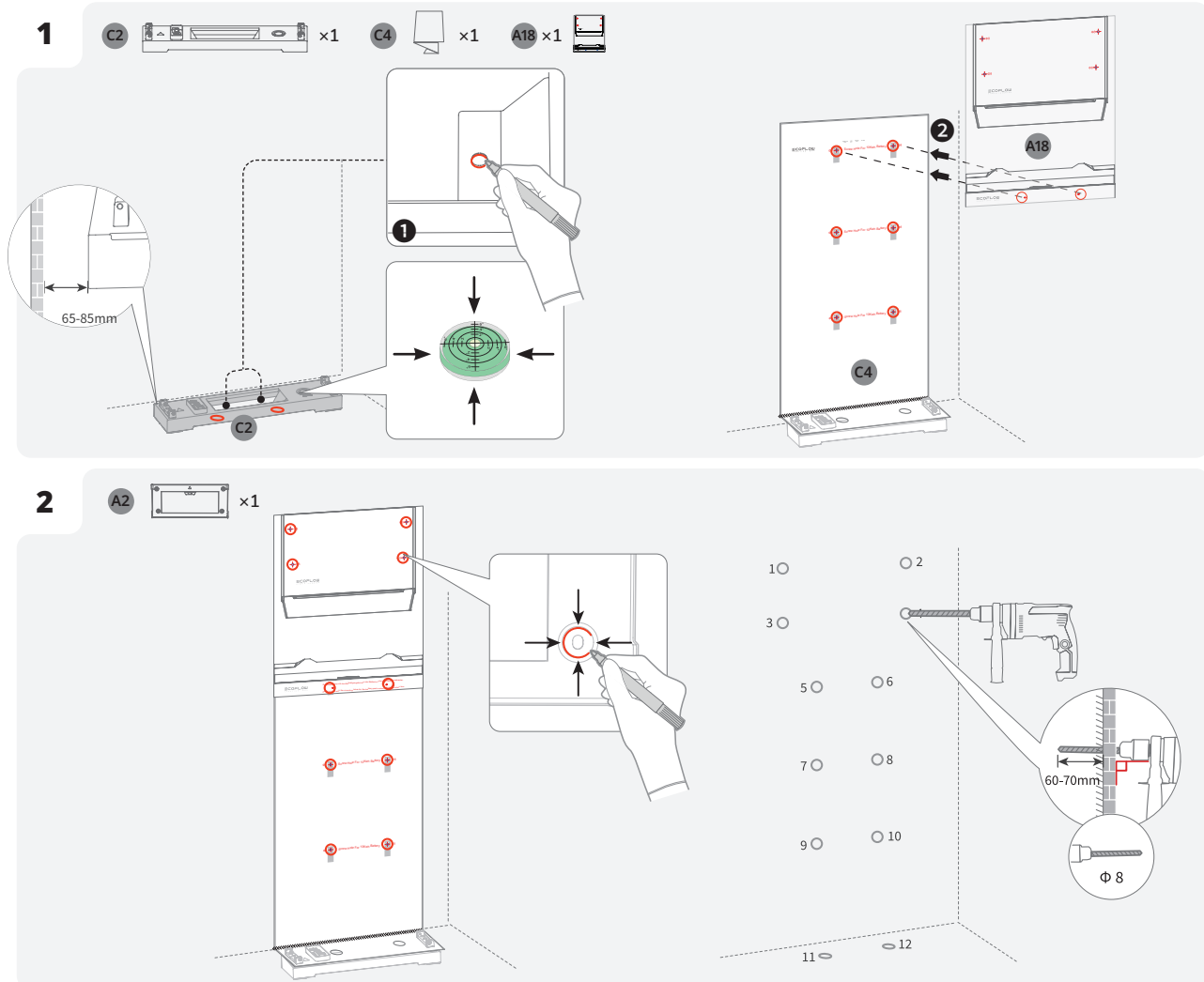

3 A10 x2

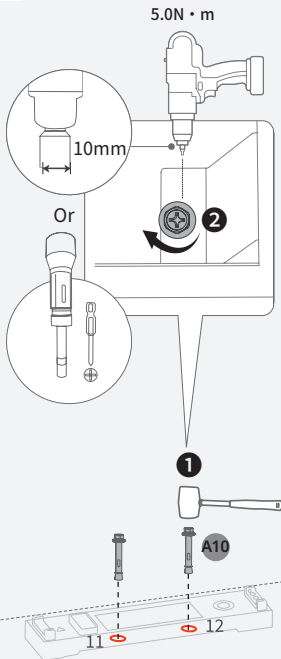

4 B1 x1 B2 x2 B3 x4

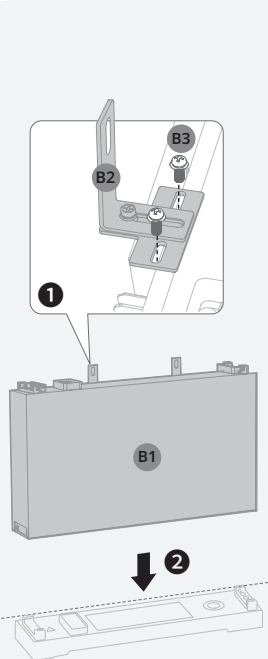

5 A10 x2 B3 x4

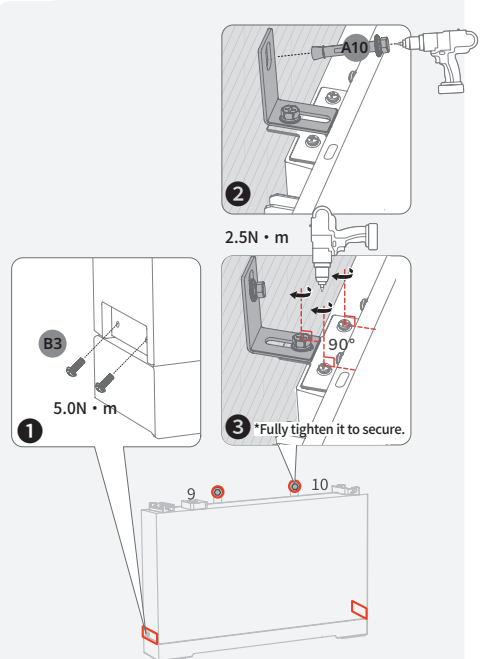

6 C1 x1 B3 x4

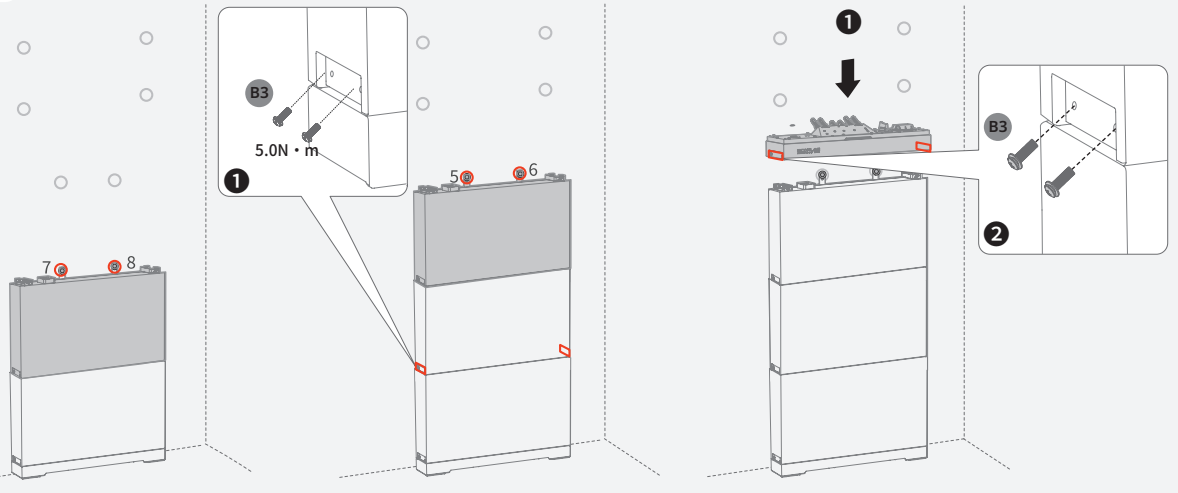

Installing Inverter

NOTICE

- Mount the inverter vertically or tilted back (<math><30^\circ</math>) to facilitate the heat dissipation of the inverter.

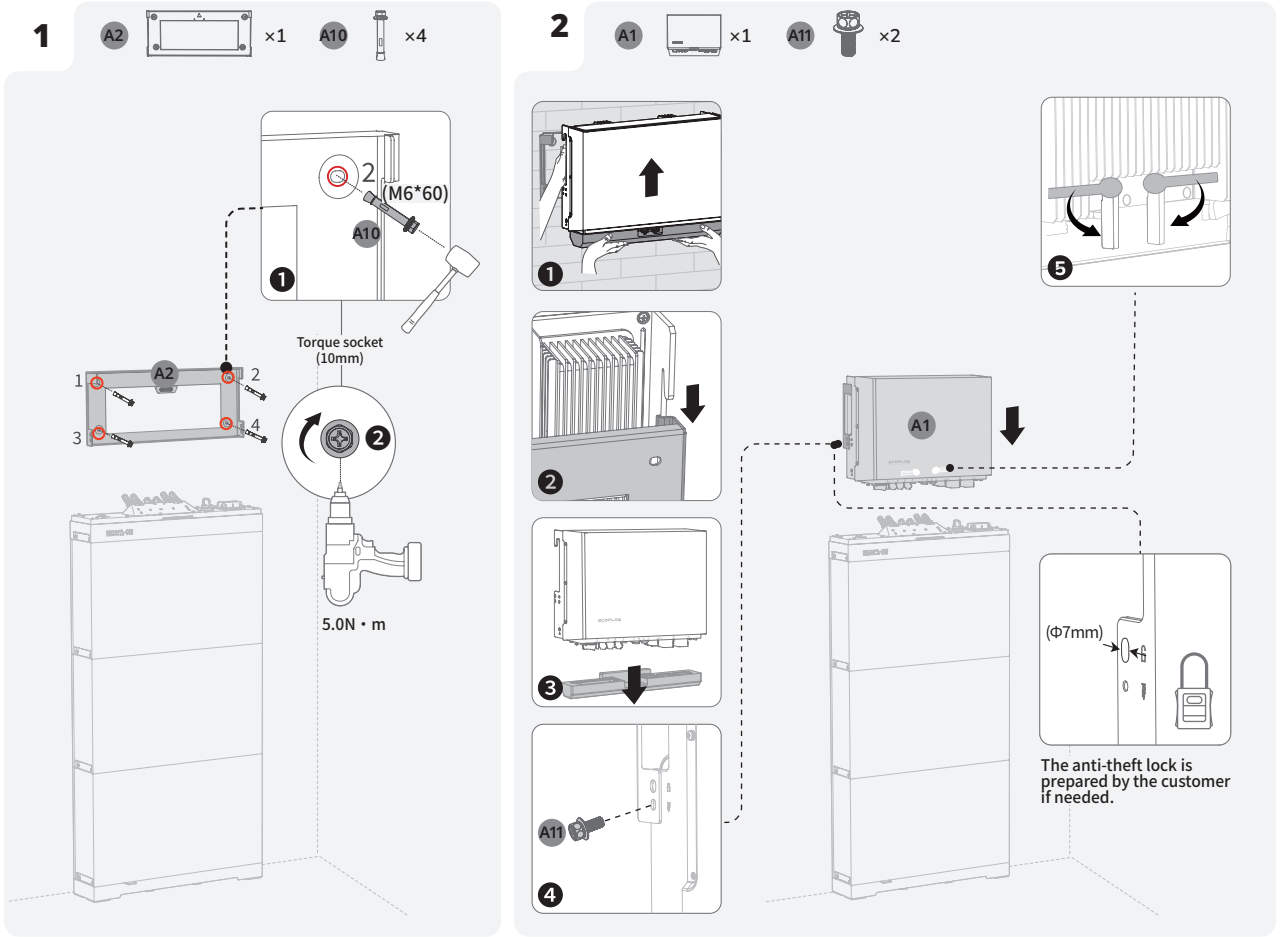

Single EcoFlow PowerOcean System

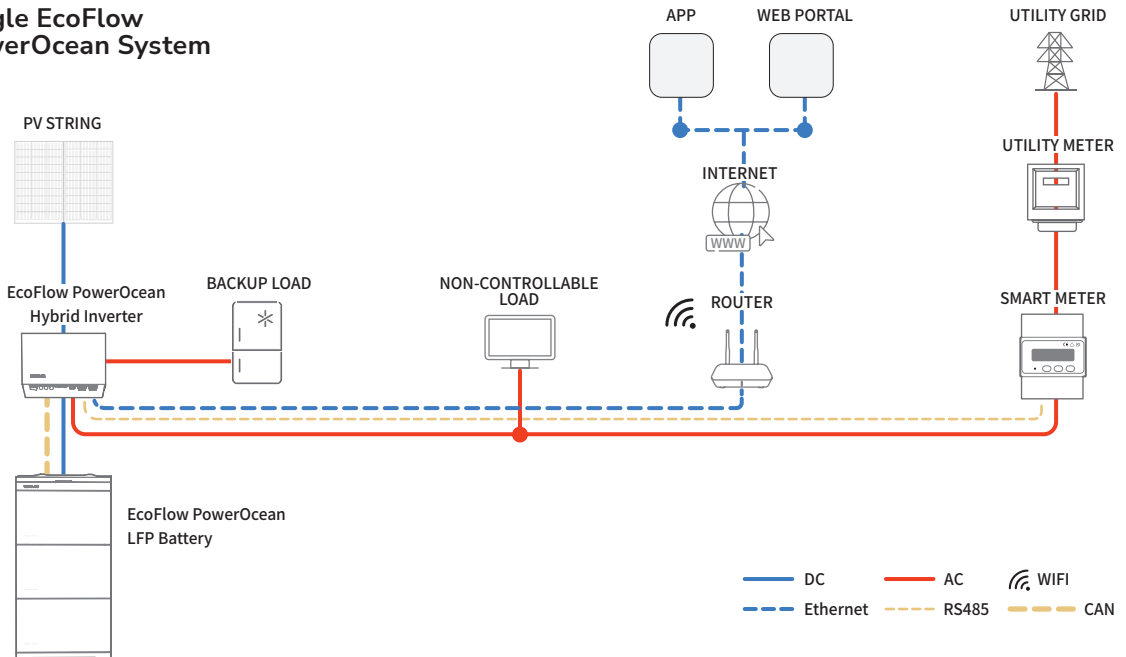

(Optional) EcoFlow PowerOcean System Cascading

NOTICE

- In the PowerOcean cascading scenario, the primary and secondary inverters are both EF HD-P3-(6K0-12K)-S1, and a maximum of two EF HD-P3-(6K0-12K)-S1 can be cascaded.
- In the PowerOcean cascading scenario, the two EF HD-P3-(6K0-12K)-S1 connected to the power grid must meet the local power grid requirements.

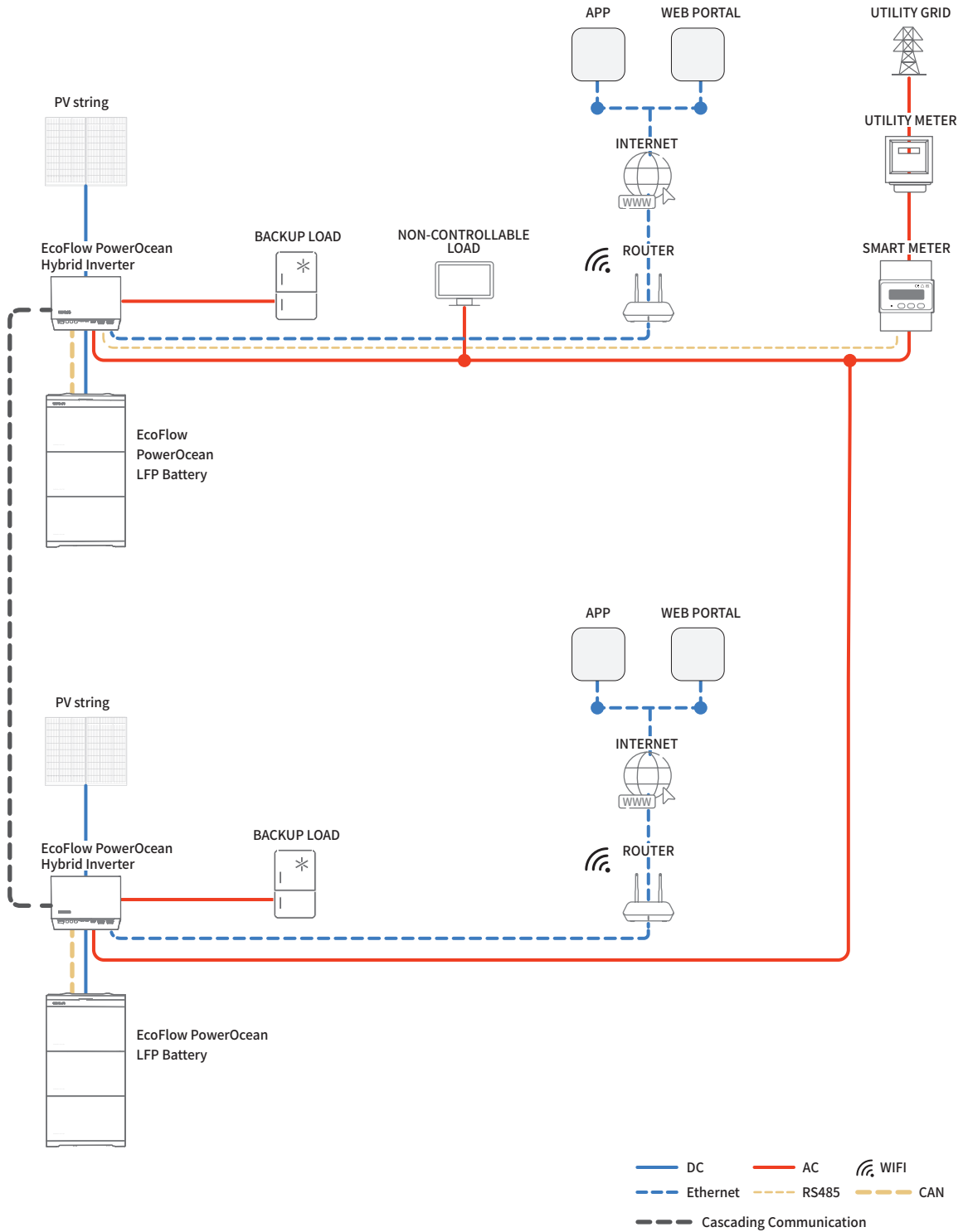

| (Optional) Integrating Existing PV System to the EcoFlow PowerOcean System

EcoFlow PowerOcean system is compatible with any single/three-phase PV grid-tied system. An existing PV system can be integrated to be a PV Energy Storage System (ESS) by connecting to the GRID terminal of the PowerOcean hybrid inverter. The power generation from the existing PV inverter will be firstly provided to the loads and then charge the battery. When the feeding power of third-party inverter is less than 200W, it will not charge the battery. With the self-powered mode of the EcoFlow PowerOcean system, the self-consumption rate of the new system, and the self-sufficiency rate of residential energy will be greatly improved, reducing electricity costs.

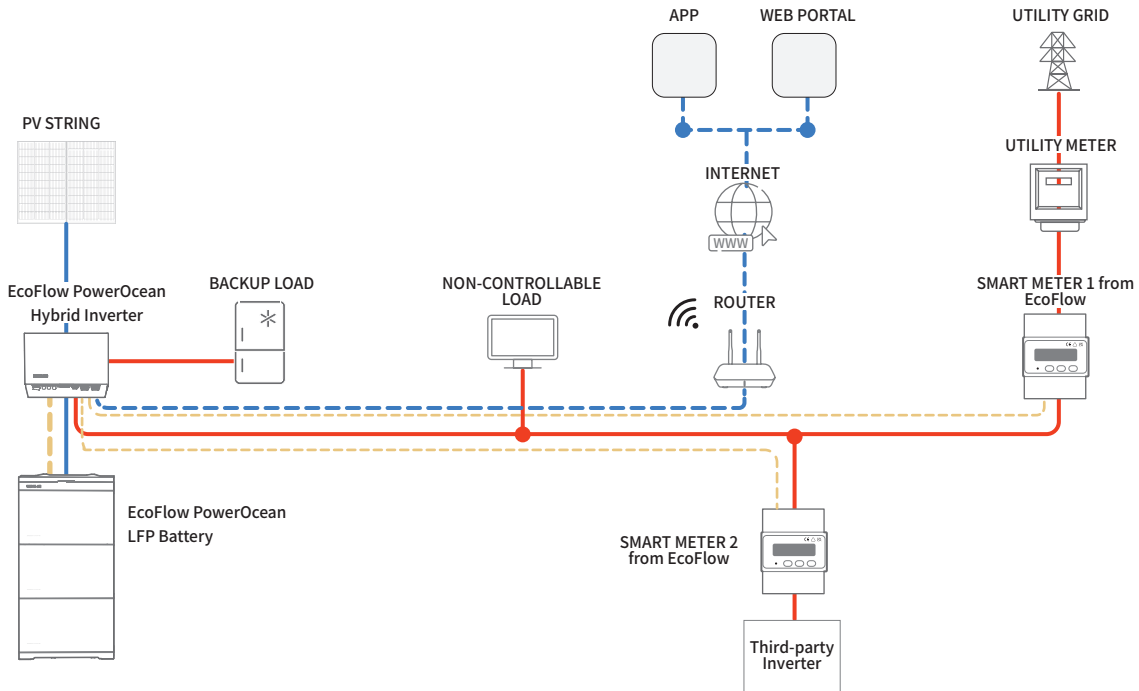

| (Optional) Integrating SG-READY certified Heatpump or EV Charger to the EcoFlow PowerOcean System

EcoFlow PowerOcean hybrid inverter is compatible with EcoFlow EV Charger (PowerPulse), Heatpump (PowerHeat), any other SG-Ready certified Heatpump. When connected with the PowerOcean system, a SG-Ready certified Heatpump or EV Charger will be powered by PV strings, battery and utility grid. Effortlessly manage, monitor, and control your devices through a sleek, user-friendly interface via app or web management. With the self-powered mode of the EcoFlow PowerOcean system, the self-consumption rate of the system, and the self-sufficiency rate of residential energy will be greatly improved, reducing electricity costs.

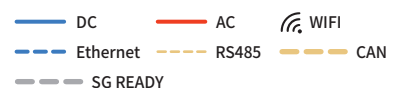
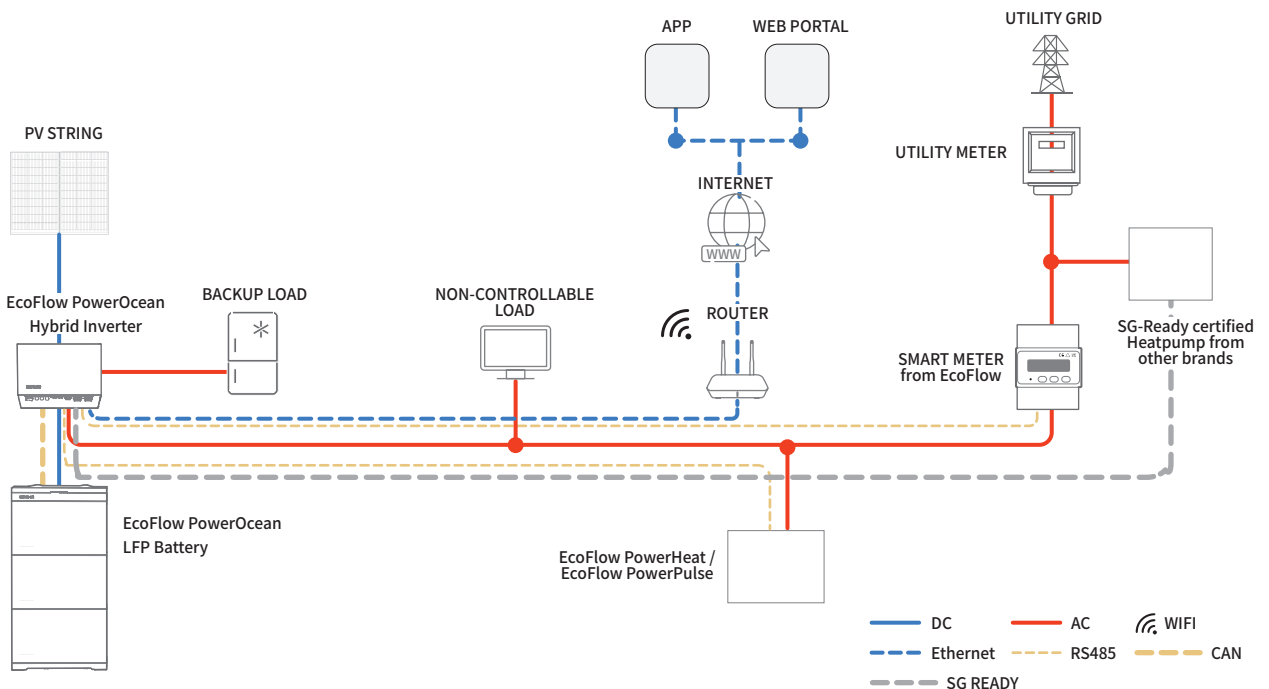

Electrical Connection

CAUTION

- All electrical connections must be carried out by a professionally trained and certified electrician.

NOTICE

- Please purchase cables that meet local certification standards.
- Do not remove the protective cap of unused terminals. Otherwise, the IP rating of the inverter will be affected.
- The cable colors shown in the figures are for reference only. Select an appropriate cable according to the local standards.

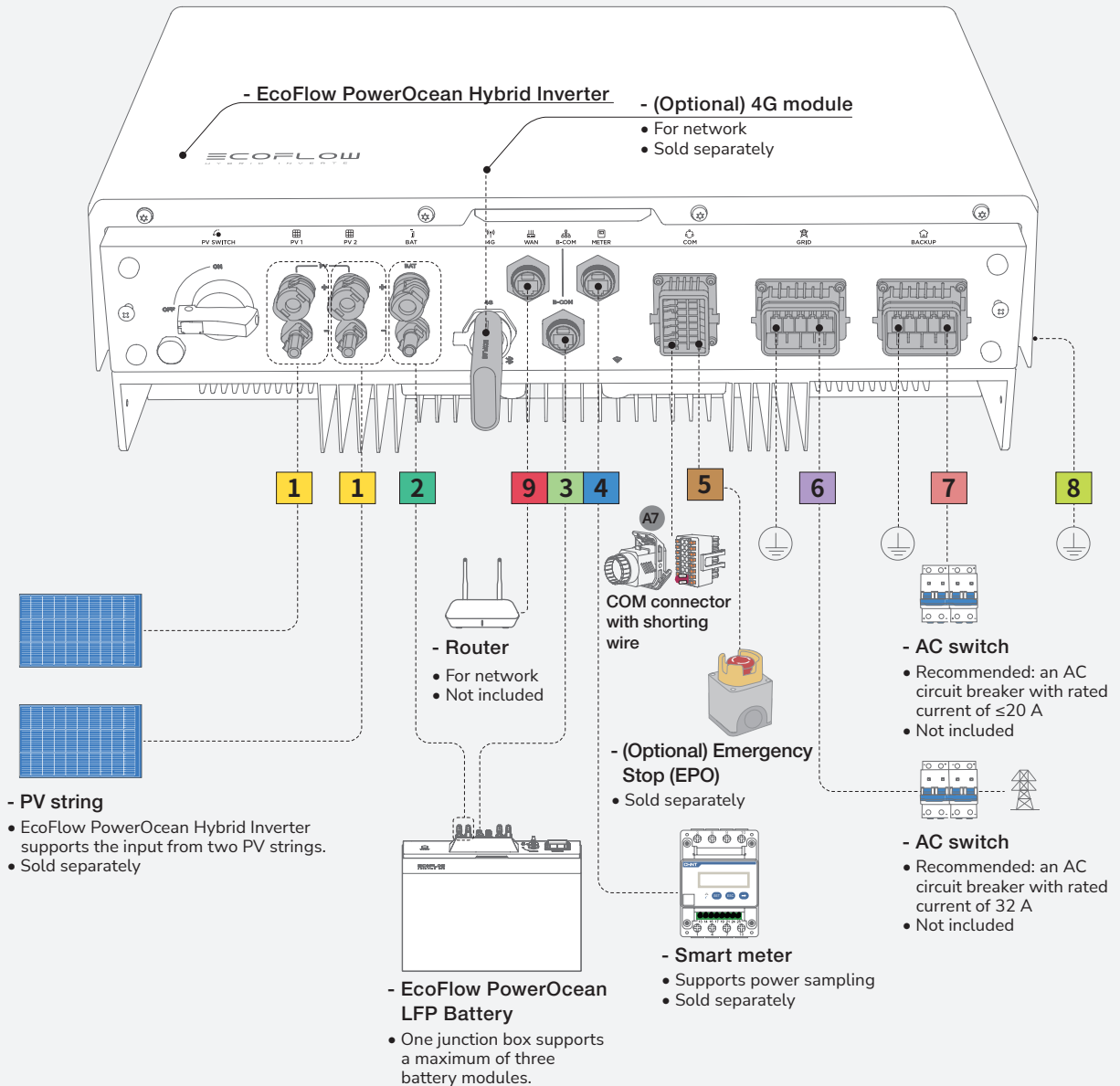

LEGEND

- | | |
|---|---|
| 1 PV Input cable | 5 (Optional) COM terminal communication cable-Emergency Stop Button / Inverter cascading |
| Conductor cross-sectional area: 4 mm ² to 6 mm ² with a rated voltage greater than or equal to 1000V DC | Shielded Twisted Pair 2*0.5mm ² |
| 2 Battery power cable | 6 Grid cable |
| Conductor cross-sectional area: 4mm ² with a rated voltage greater than or equal to 1000V DC | 4 mm ² to 6 mm ² |
| 3 Battery communication cable with shield | 7 Backup cable |
| CAT 5E 8*0.2mm ² | 4 mm ² to 6 mm ² |
| 4 Smart meter communication cable | 8 Ground cable |
| CAT 5E 8*0.2mm ² | 6mm ² |
| | 9 Ethernet cable (optional) |
| | Cat 5e or higher shielded network cable |

Single EcoFlow PowerOcean Wiring Diagram

NOTICE

- N and PE wiring via GRID and BACKUP ports of the inverter vary based on the regulation requirements of different regions. Refer to the specific requirements of local regulations.

A. N AND PE CABLES ARE CONNECTED TOGETHER IN THE MAIN PANEL FOR WIRING.

NOTICE

- For Australia and New Zealand, the N cable of GRID side and BACK-UP side must be connected together according to the wiring rules AS/NZS_3000. Otherwise BACK-UP function may be abnormal and risky.
- The following diagram is applicable to areas in Australia, New Zealand, etc.

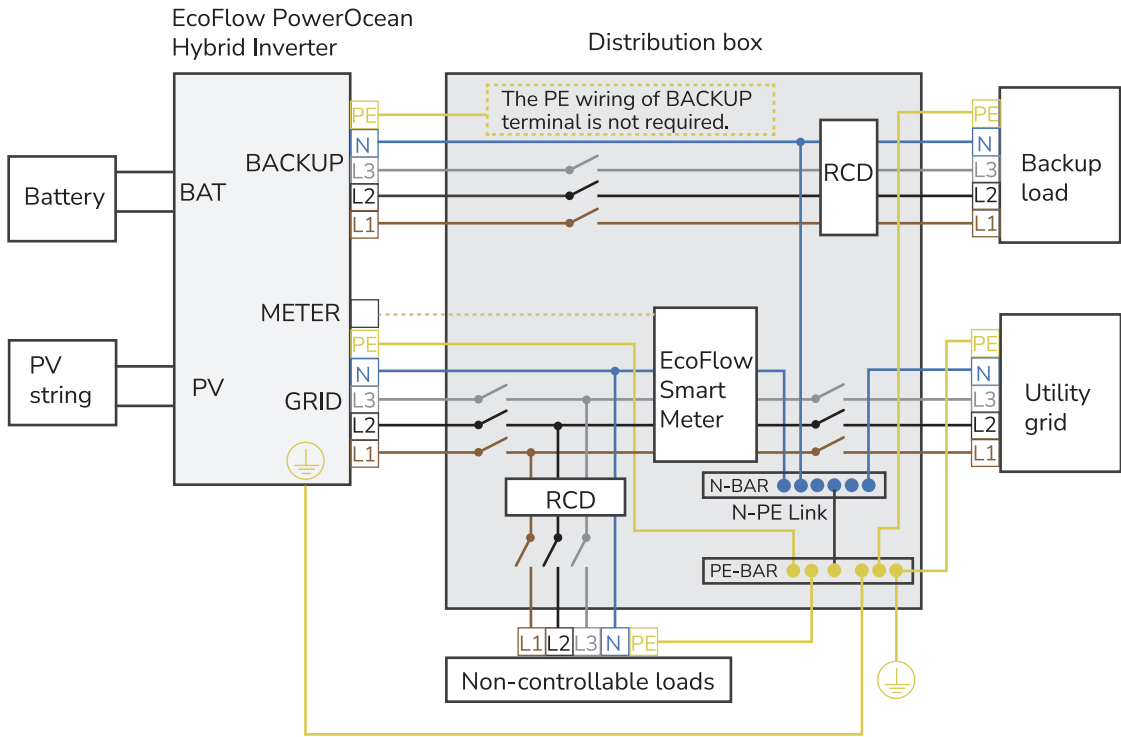

B. N AND PE CABLES ARE SEPARATELY WIRED IN THE MAIN PANEL.

NOTICE

- The following diagram is applicable to other countries whose grid systems without special requirement on wiring connection.

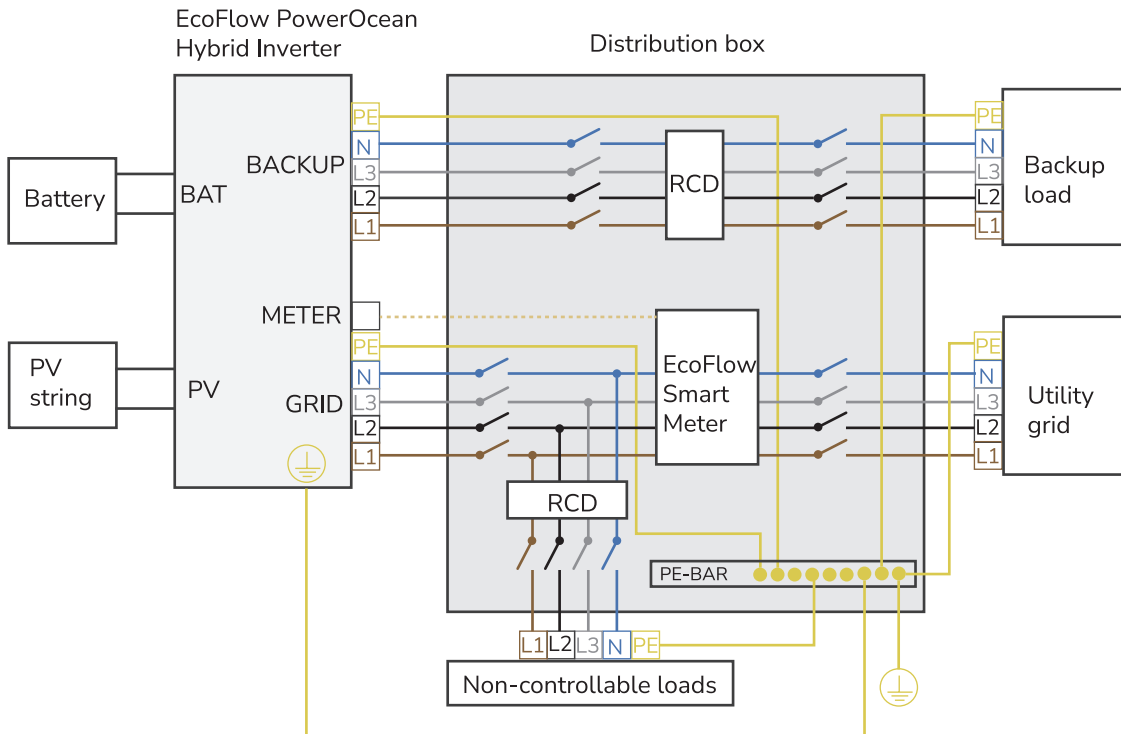

(Optional) EcoFlow PowerOcean Cascading Wiring Diagram

NOTICE

- N and PE wiring via GRID and BACKUP ports of the inverter vary based on the regulation requirements of different regions. Refer to the specific requirements of local regulations.
- For users who already have installed and expect to connect the BACKUP ports of the two inverters together, you need to rewire the BACKUP ports as wiring diagram shown, then restore all system settings to factory defaults, and go through the system commissioning procedure again, see the **System Commissioning** section.

En

A. N AND PE CABLES ARE CONNECTED TOGETHER IN THE MAIN PANEL FOR WIRING.

NOTICE

- For Australia and New Zealand, the N cable of GRID side and BACK-UP side must be connected together according to the wiring rules AS/NZS_3000. Otherwise BACK-UP function may be abnormal and risky.
- The following diagram is applicable to areas in Australia, New Zealand, etc.

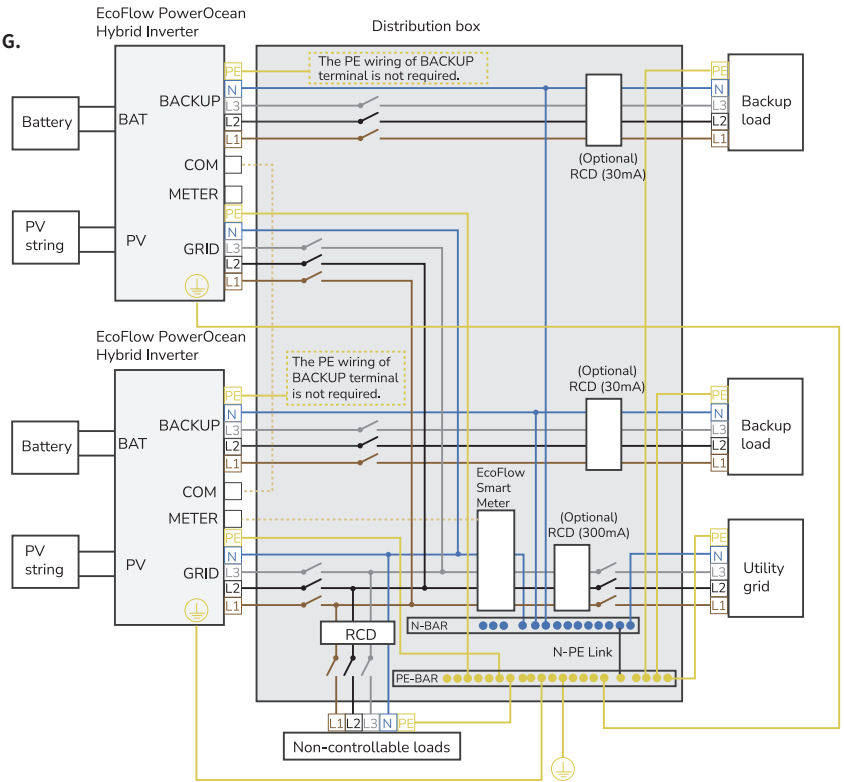

B. N AND PE CABLES ARE SEPARATELY WIRED IN THE MAIN PANEL.

NOTICE

- The following diagram is applicable to other countries whose grid systems without special requirement on wiring connection.

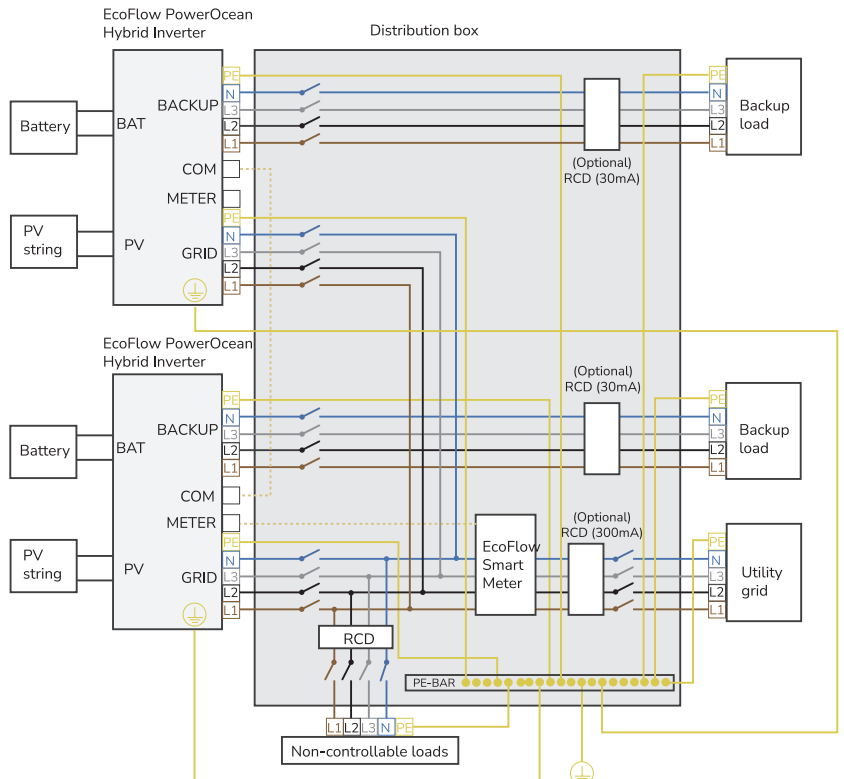

Connecting PE Cables

NOTICE

- Ensure that the PE cable is connected securely.
- Wrap the wire crimping area with heat shrink tubing or insulation tape. The heat shrink tubing is used as an example.
- When using a heat gun, protect the equipment from being scorched.
- It is recommended that silica gel or paint be used around the ground terminal after the PE cable is connected.

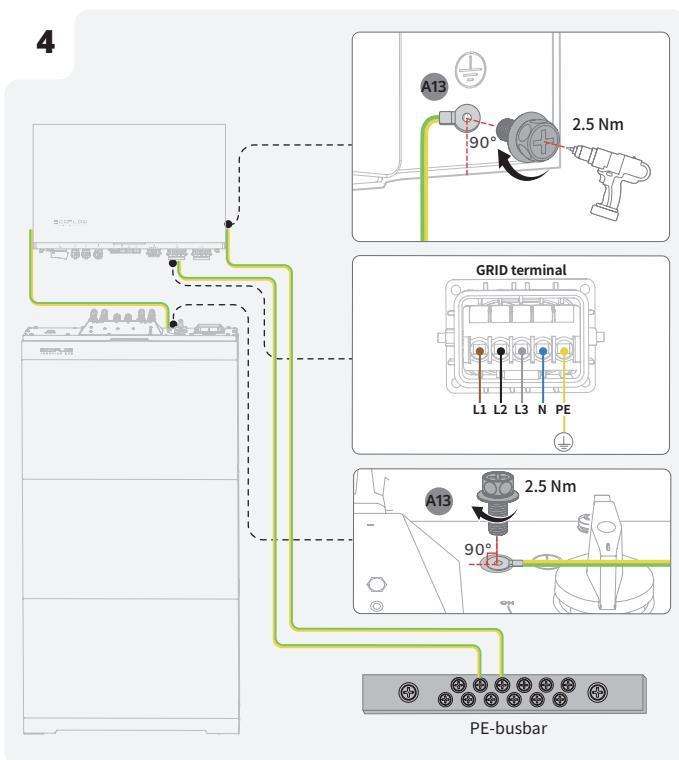
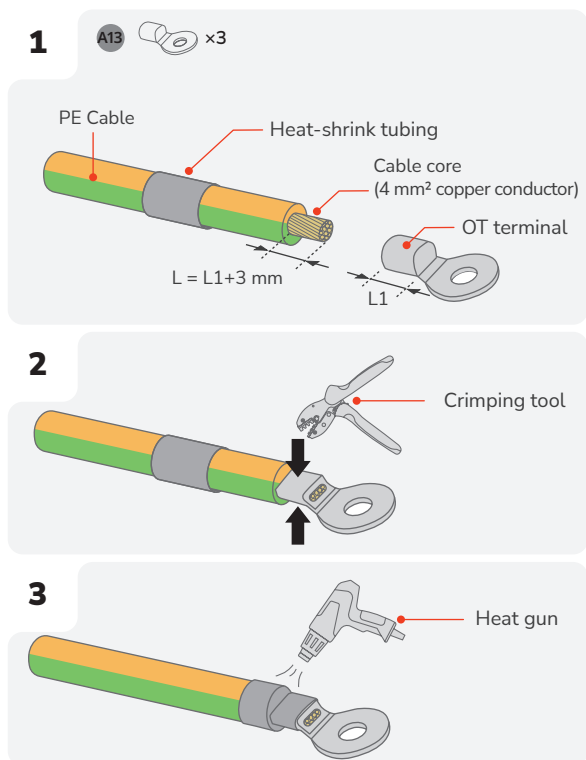

Connecting PV Input Cables

⚠ DANGER

- Before connecting the PV input cables, ensure AC switch connected to the inverter and the PV SWITCH on the inverter are OFF. Failing to do so may result in electric shocks.
- The PV string will generate lethal high voltage when exposed to sunlight. Disconnect the PV cable of PV string before connecting DC power.
- Before connection, ensure the polarity of the output of the PV array matches "PV+/"PV-" symbols.
- Before connecting the PV input cables, ensure that the impedance between the positive/negative terminals of the PV string and earth are larger than 1 MΩ. Do not ground the PV array positive/negative pole.
- When the inverter is running, it is not allowed to work on the PV input cables, such as connecting or disconnecting a PV string or a PV module in a PV string. Failing to do so may cause electric shocks.
- Do not remove the protective cap from the unused PV input terminal. Otherwise, the IP rating of the inverter will be affected.
- Ensure that the maximum DC voltage and the maximum short-circuit current of any string do not exceed the allowed range specified in the "Technical Parameters" of the User Manual.

NOTICE

- In order to avoid malfunction, please do not connect any PV modules that have a risk of leakage current to the inverter.
- In order to avoid lightning damage to the inverter, it is recommended to add a surge protection switch at the PV junction box.
- After the positive and negative connectors snap into place, slightly pull the PV input cables back to ensure that they are connected securely.
- It is not recommended that connect different brands or models of PV modules to one MPPT circuit, or connect PV modules of different orientation or angles to one PV string.

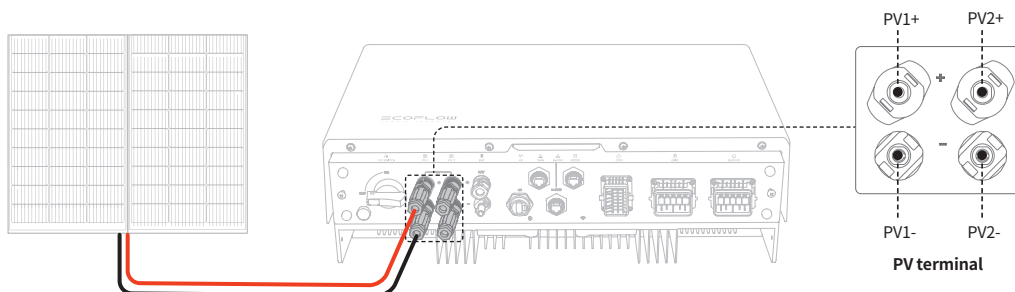

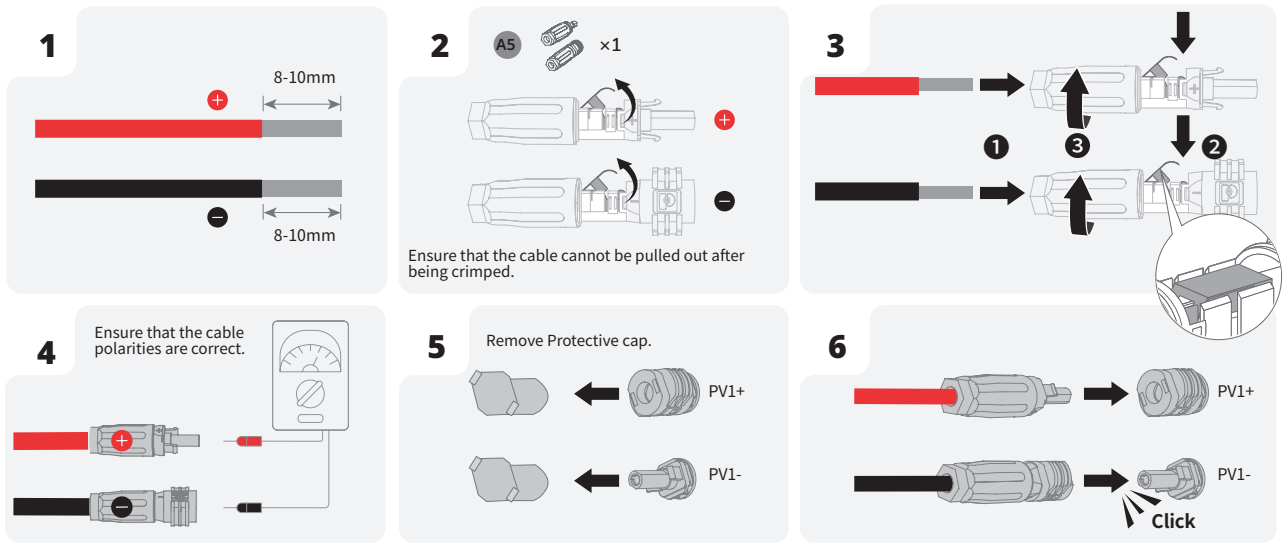

💡 Set the multimeter to DC gear to measure the voltage at the DC position. If the voltage is a negative value, the PV input polarity is incorrect and needs correction. If the voltage is greater than 1000 V, too many PV modules are configured to the same string. Remove some PV modules.

If the PV input cable is reversely connected and the PV SWITCH is set to ON, first set the PV SWITCH to the OFF position, then remove the positive and negative connectors, and correct the polarities of the PV input cables.

REMOVING THE PV TERMINAL



WARNING

- Before removing the positive and negative connectors, ensure that the PV SWITCH is OFF.

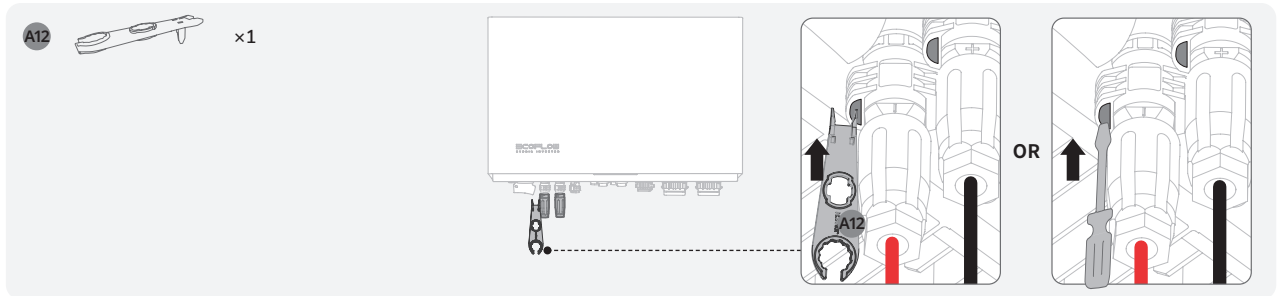

Connecting GRID Cables

CAUTION

- Before installing, operating, and maintaining the equipment, always disconnect it from all power.
- Do not connect loads between the inverter and the AC switch that directly connects to the inverter.
- Ground the PE pole of GRID connector and the equipment enclosure.
- Do not connect the GRID connector to the BACKUP terminal of the inverter.

NOTICE

- For single PowerOcean system, RCD (type A) with rated residual operating current of 100 mA (AC-GRID) would be recommended if there is additional protection by RCD shall be provided for local electrical installation, while the use of an RCD with lower rated residual operating current is also permitted if it is required by the specific local electrical codes.
- For PowerOcean system cascading, RCD (type A) with rated residual operating current of 300 mA (AC-GRID) would be recommended.

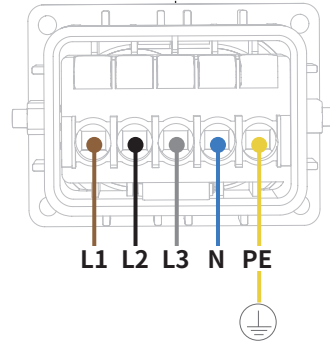
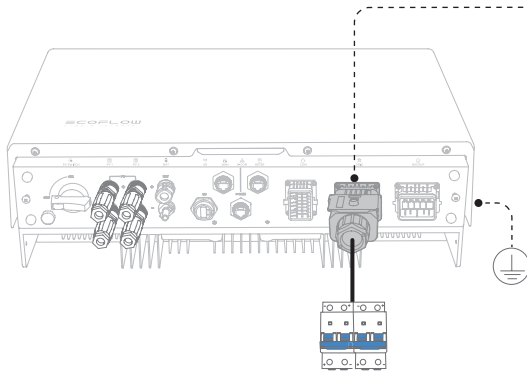

GRID terminal

- L1 · a-phase line 1
- L2 · b-phase line 2
- L3 · c-phase line 3
- N · Neutral wire
- PE · Ground wire

FIVE-CORE WIRE (L1, L2, L3, N, PE)

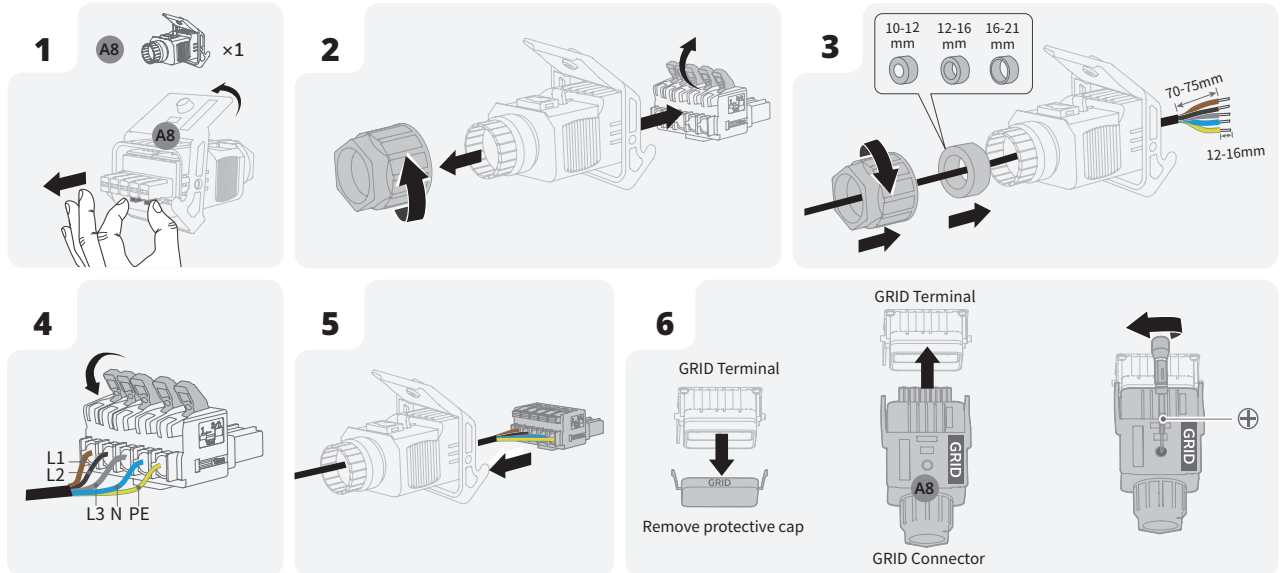

Connecting BACKUP Cables

CAUTION

- Before installing, operating, and maintaining the equipment, always disconnect it from all power.
- Do not connect the BACKUP connector to the GRID terminal of the inverter.
- It is not recommended to connect loads with high starting power to BACKUP terminal, such as vacuum cleaner, air conditioner, etc.

NOTICE

- RCD (type A) with rated residual operating current of 30mA (AC-BACKUP) would be recommended if there is additional protection by RCD shall be provided for local electrical installation, while the use of an RCD with lower rated residual operating current is also permitted if it is required by the specific local electrical codes.

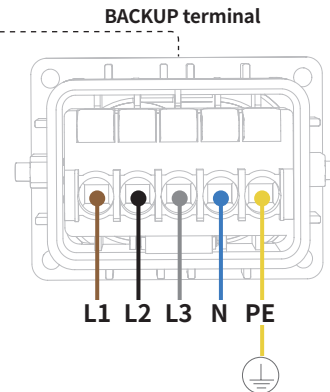
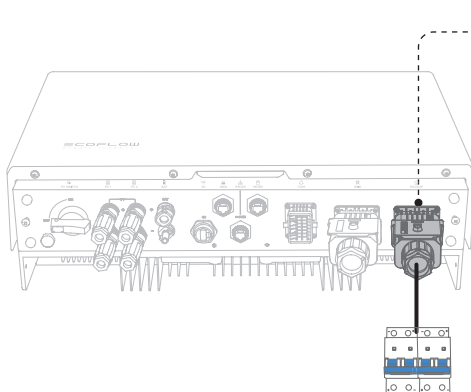

BACKUP terminal

- L1 · a-phase line 1
- L2 · b-phase line 2
- L3 · c-phase line 3
- N · Neutral wire
- PE · Ground wire

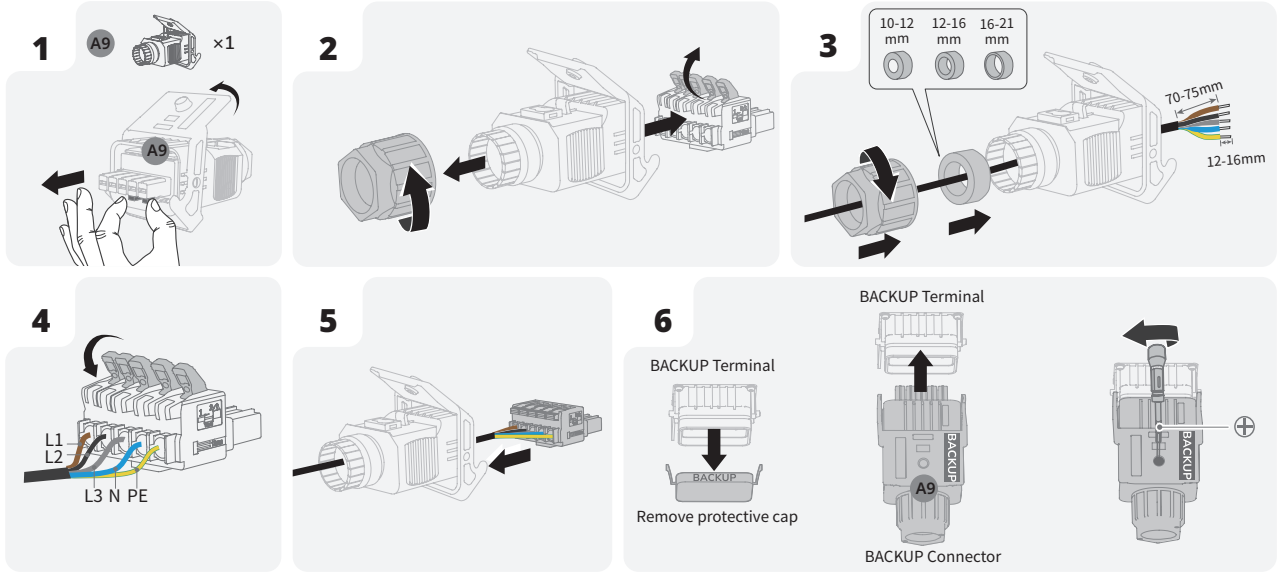

Connecting Battery Power Cables

- ⚠ DANGER** • Before disconnecting the Battery terminals, you MUST set the BATTERY SWITCH on top of the Junction Box to OFF position, then press and hold the BATTERY ON/OFF button on the right side of the junction box for 10 seconds, until the indicator is off.
- ⚠ CAUTION** • Both ends of the positive cable are positive connectors. Both ends of the negative cable are negative connectors.

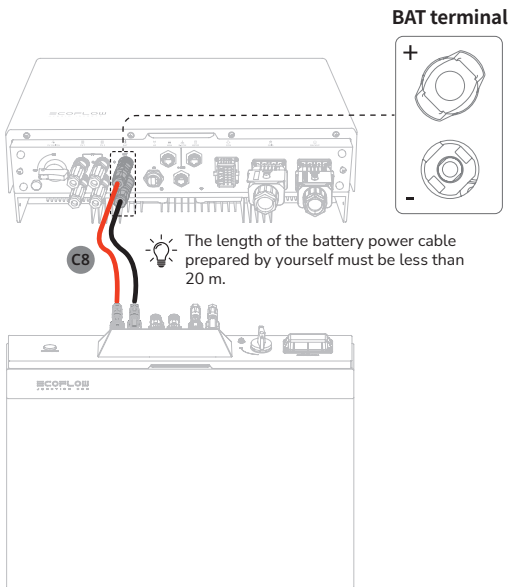

- OPTIONAL

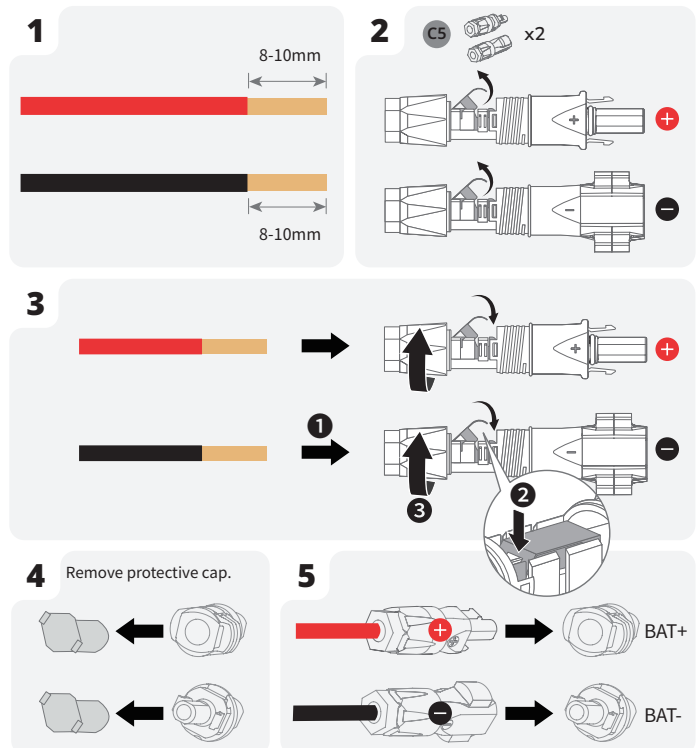

Connecting Battery Communication Cables

NOTICE

- Connectors are required at both ends of the battery communication cable.
- It is recommended to use COM1 for communication between the inverter and battery, COM2 for battery parallel communication.

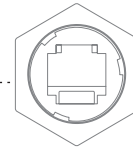
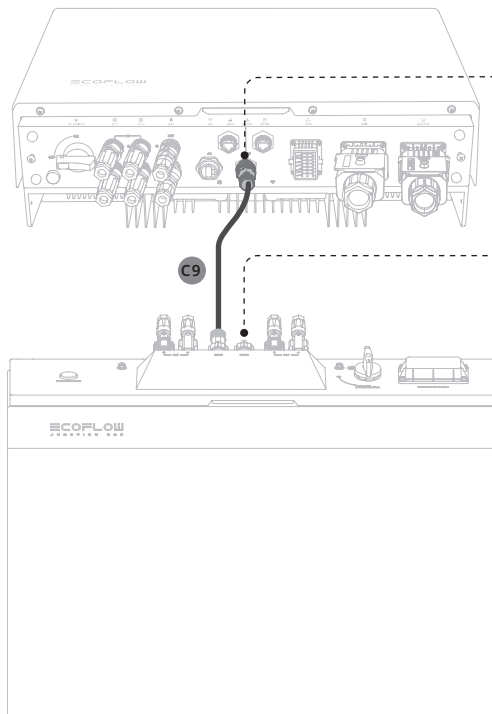

Battery communication port (BAT)

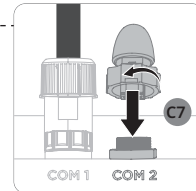

CAUTION

- It is a MUST to install a termination resistor to the unused B-COM terminal of the battery junction box, otherwise it would cause the system to malfunction.
- Some battery junction boxes already have termination resistors installed as delivered, while some do not. The actual deliverables may vary.
- As for battery junction boxes already have termination resistors installed as delivered, remove the termination resistor to use the B-COM terminal.

- OPTIONAL

1 A6 ×2

2 T-568B

2

3

4

4

5

5

10mm

Pull back the crimped RJ45 module to ensure that it is assembled securely and in place, 10mm length of which shall be exposed. Otherwise, you need to rotate it by 90 degrees, as shown in the previous step.

(Optional) Cascading Batteries

NOTICE

- One battery junction box supports a maximum of 3 battery packs.
- Up to 9 battery packs (maximum 45.9 kWh) can be cascaded.
- Do not remove the protective cap of unused DC input terminals. Otherwise, the IP rating of the inverter will be affected.
- When installing two sets of batteries (number of battery packs ≥ 4), ensure that the minimum clearance between the two sets of batteries is 400mm, while greater clearance is also permitted if it is required by the specific local electrical codes.

CAUTION

- It is a MUST to install a termination resistor to the unused B-COM terminal of the battery junction box, otherwise it would cause the system to malfunction.
- Some battery junction boxes already have termination resistors installed as delivered, while some do not. The actual deliverables may vary.
- As for battery junction boxes already have termination resistors installed as delivered, remove the termination resistor to use the B-COM terminal.

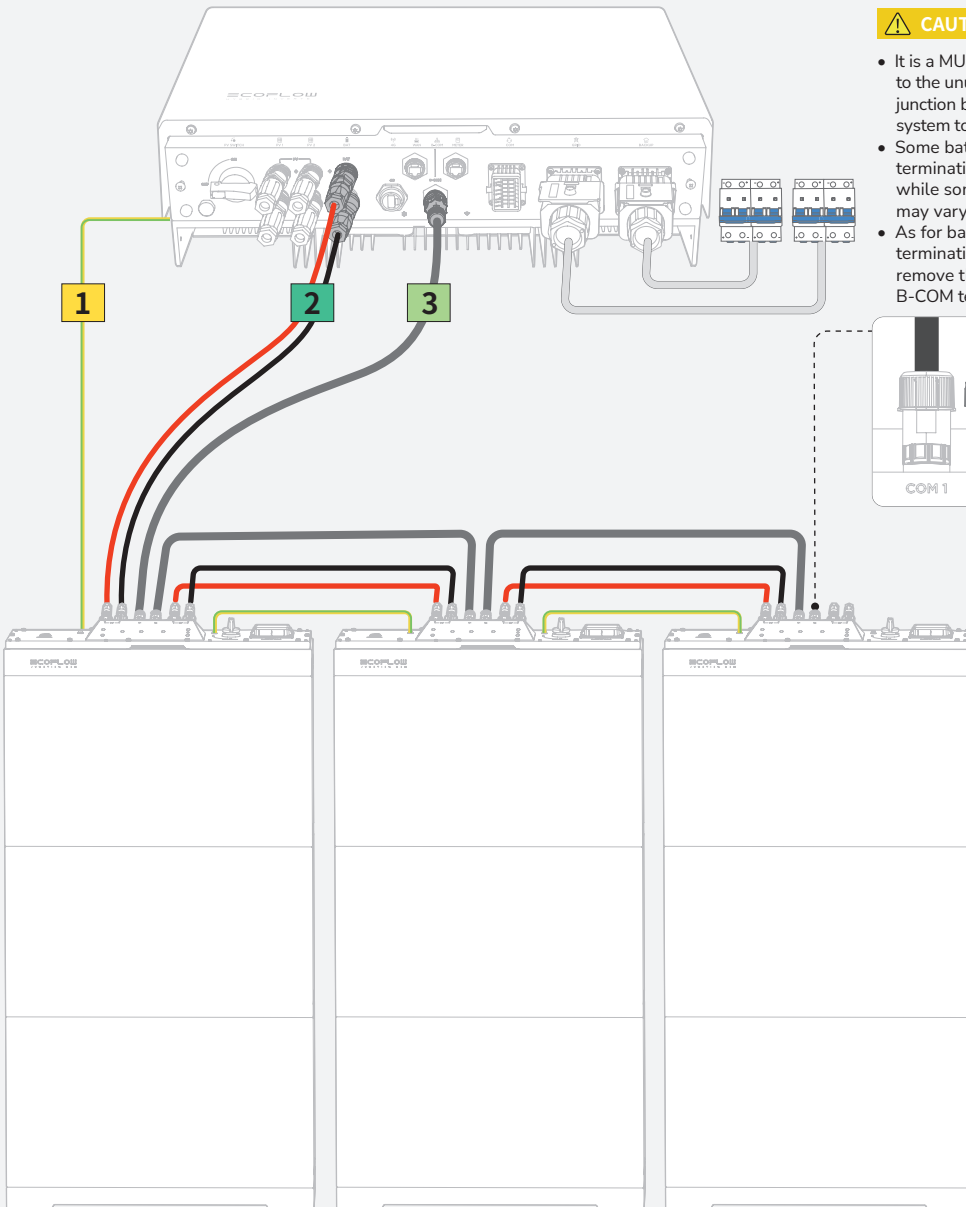
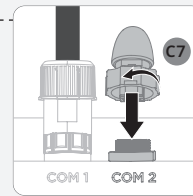

LEGEND

- 1** For details about connecting grounding terminals between the battery junction boxes, see the section **Connecting PE Cables** in this guide.
- 2** For details about connecting DC input terminals (BAT+/-) between the battery junction boxes, see the section **Connecting Battery Power Cables** in this guide.
- 3** For details about connecting battery communication terminals (B-COM) between the battery junction boxes, see the section **Connecting Battery Communication Cables** in this guide.

Installing COM Connector With Shorting Wire

NOTICE

- COM terminal supports logic interface connection. Logic interface is required by some local regulations that can be operated by a simple switch or contactor.
- When the switch is closed, the inverter can operate normally. When the switch is opened, the inverter will reduce its active power to zero within 5s.
- Pin14 and Pin16 of COM terminal is used for the logic interface connection.
- Voltages between Pin2 and Pin4, Pin6 and Pin8 of the COM terminal are both less than or equal to 24V.

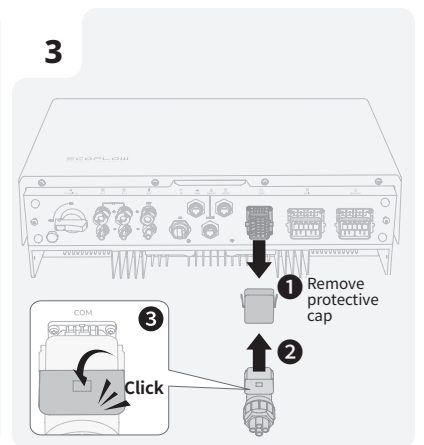
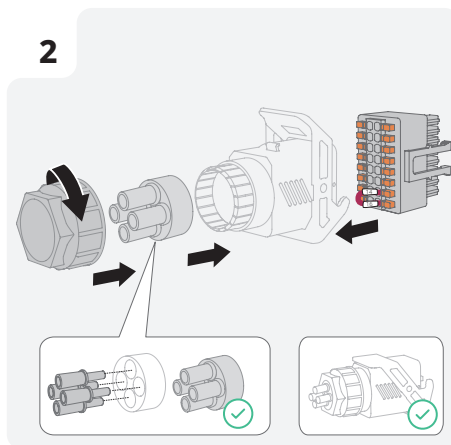
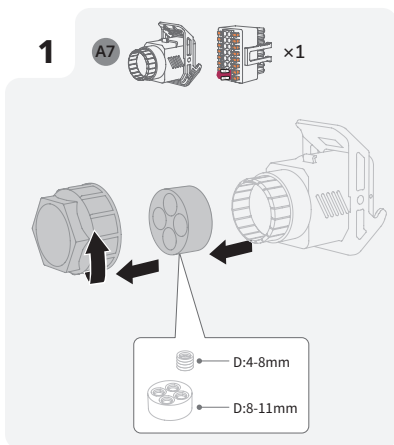
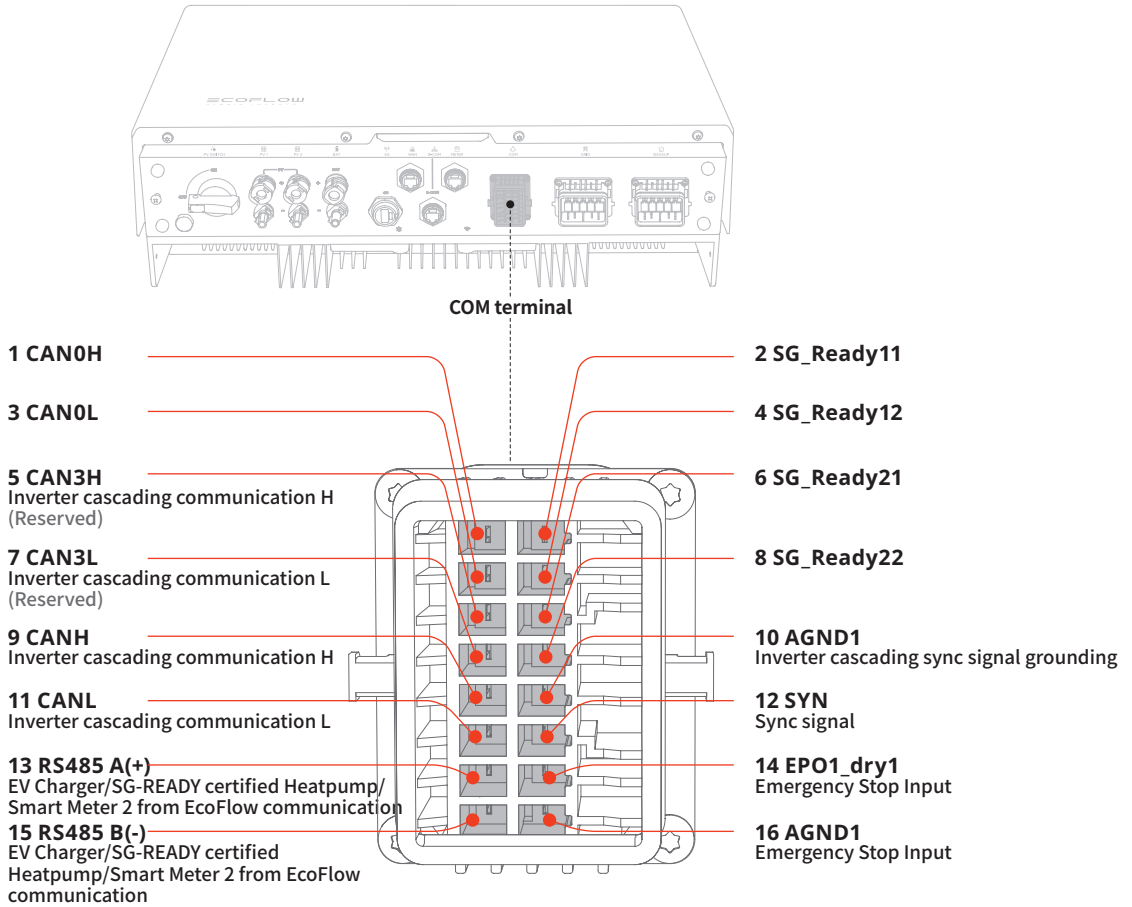

(Optional) Installing Emergency Stop (EPO)

NOTICE

- Before installing EPO, please remove the shorting wire between PIN14 and PIN16.

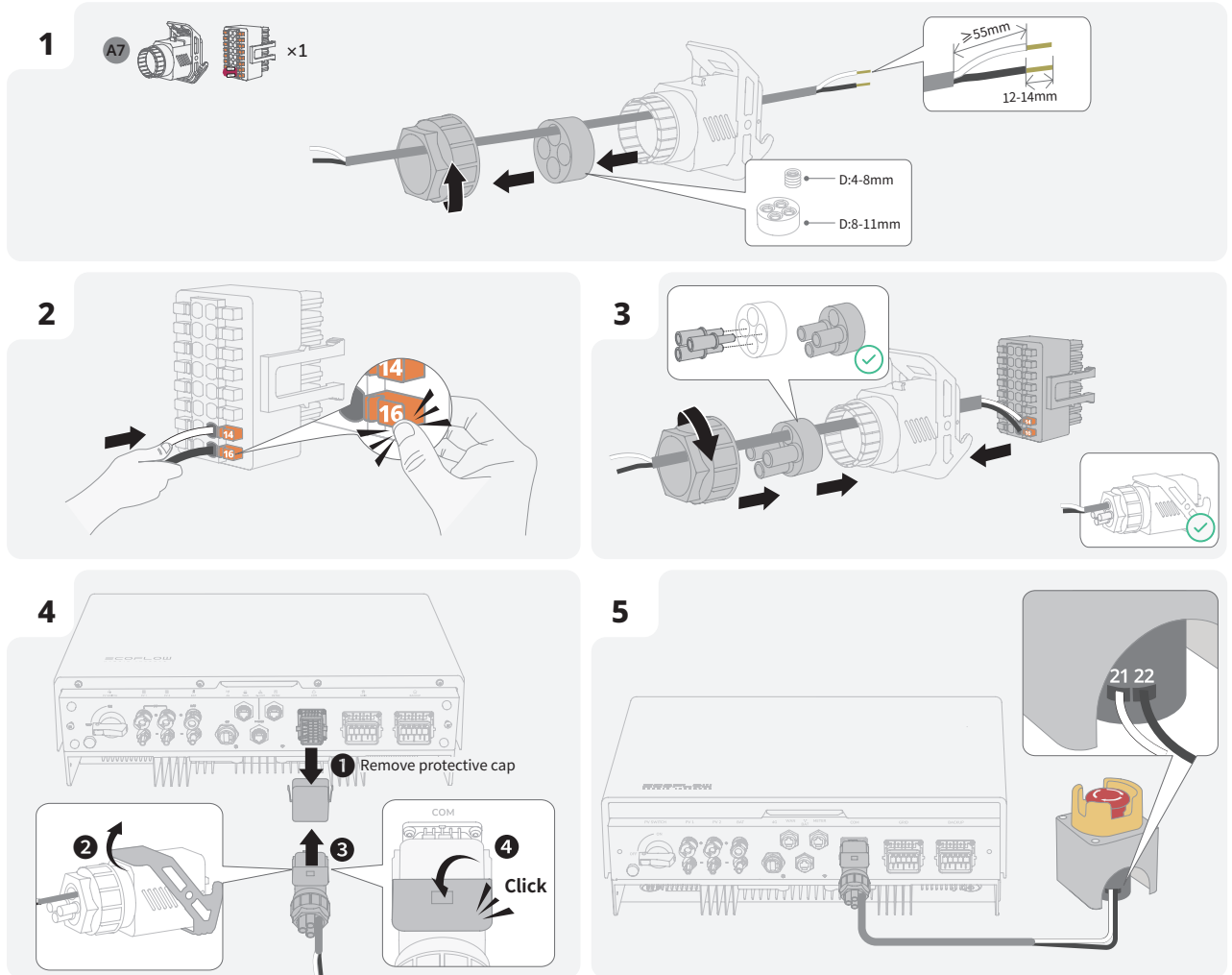

(Optional) Connecting Communication Cable of Smart Meter 2 from EcoFlow to the PowerOcean System

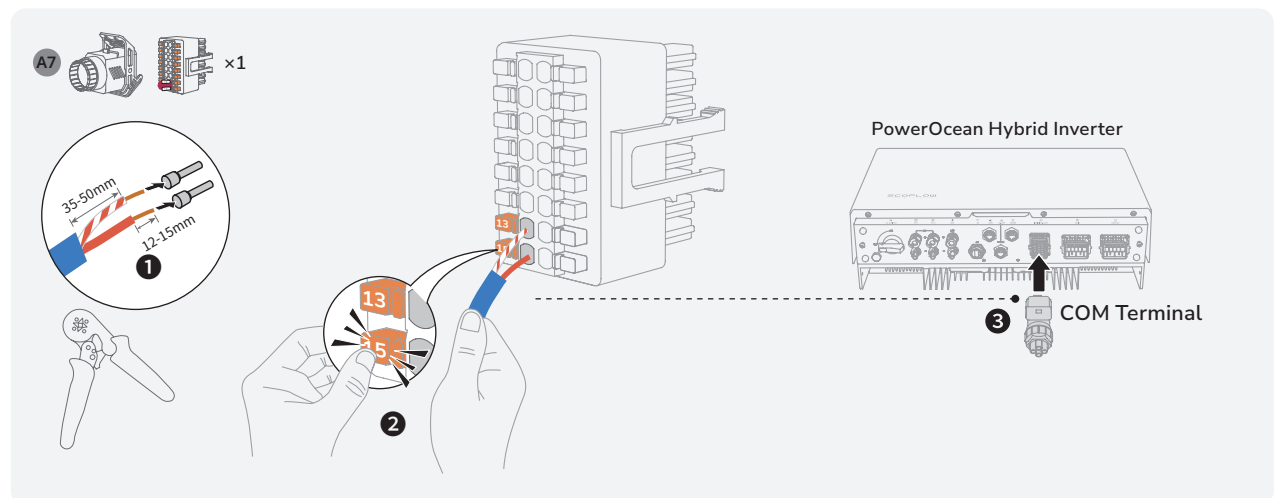

(Optional) Connecting Communication Cable of EcoFlow PowerHeat/EcoFlow PowerPulse to the PowerOcean System



Method 1: Wired Connection (RS485)

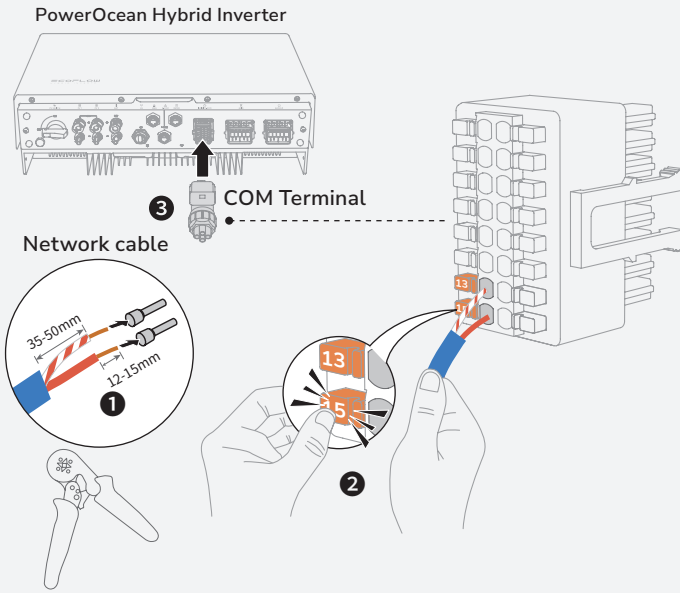

Method 2: Wireless Connection (Wi-Fi)

Accessing the same wireless network



- Go to PowerOcean **Device Settings** to add device on system component page. See the **System Commissioning** section.

(Optional) Connecting Communication Cable of SG-READY certified Heatpump from other brands to the PowerOcean System

NOTICE

- The cable colors shown in the figures are for reference only. For detailed instructions on the installation and wiring scheme of the heatpump, please refer to the guide that comes together with it.

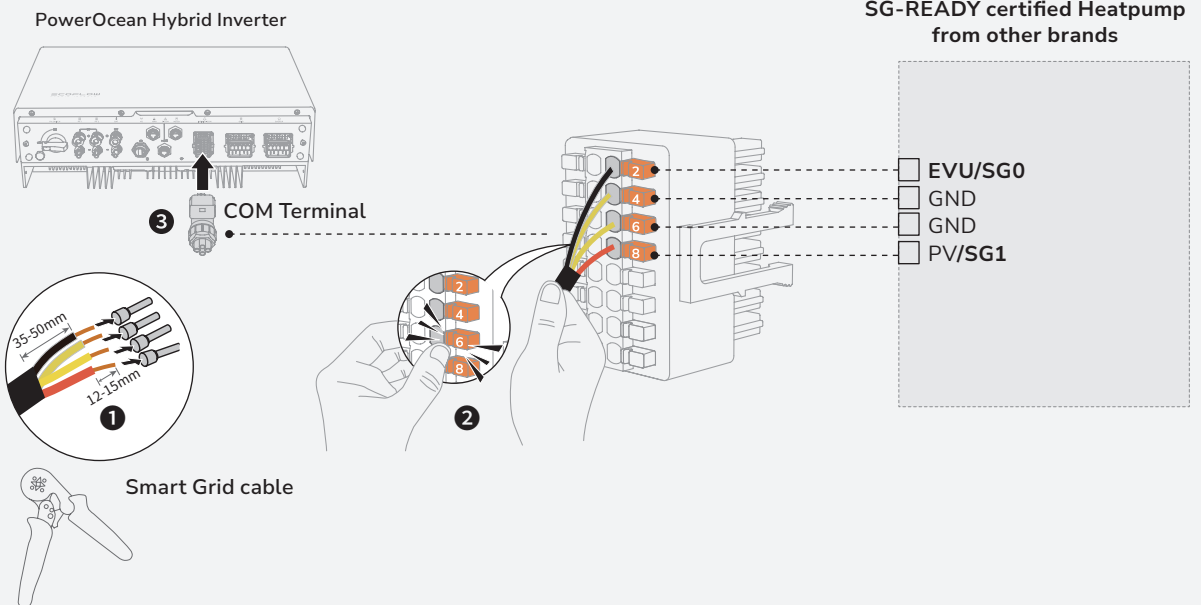



PowerOcean Hybrid Inverter

PowerOcean Hybrid Inverter

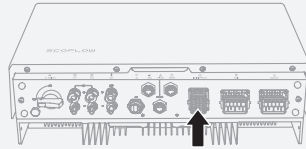
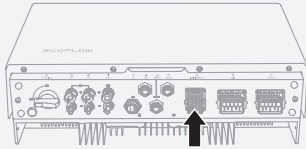

3 COM Terminal

3 COM Terminal

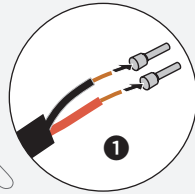
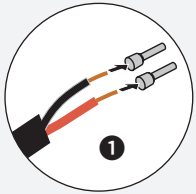

Crimping tool (for tubular terminal)

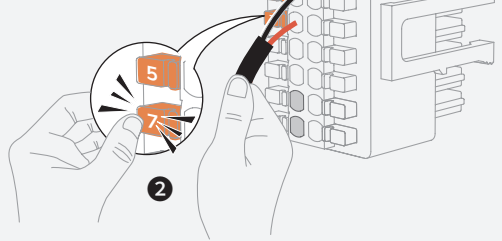

COM Connector (INV1)

COM Connector (INV2)

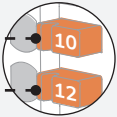
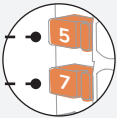

Connecting Smart Meter

NOTICE

- It is recommend to use of CAT5 or higher rating network cable.
- Smart meter is sold separately, which has been preset parameters before delivered. Do not modify the relevant parameters.
- The compatibility of this product with smart meters may vary by regions and versions. For detailed instructions on the installation and wiring scheme of the smart meter for this product, please refer to the guide that comes together with the meter.
- The cable colors shown in the figures are for reference only. Select an appropriate cable according to the local standards.

1 METER SAMPLING

Find the home mains and connect the smart meter as shown in the diagram.

2 METER COMMUNICATION

Find communication port 24,25 on the meter and connect them to the meter port of inverter.

COMMUNICATION WIRING DIAGRAM

T-568B



EcoFlow Smart Meter

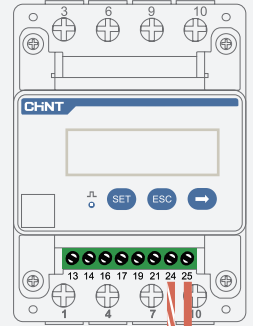

Connect pin2 with pole 25 using the orange wire.
Connect pin1 with pole 24 using the orange-white wire.

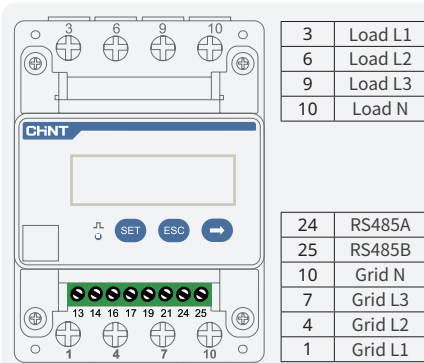

For details about assembling the communication terminal, see the section **Connecting Battery Communication Cables** in this guide.

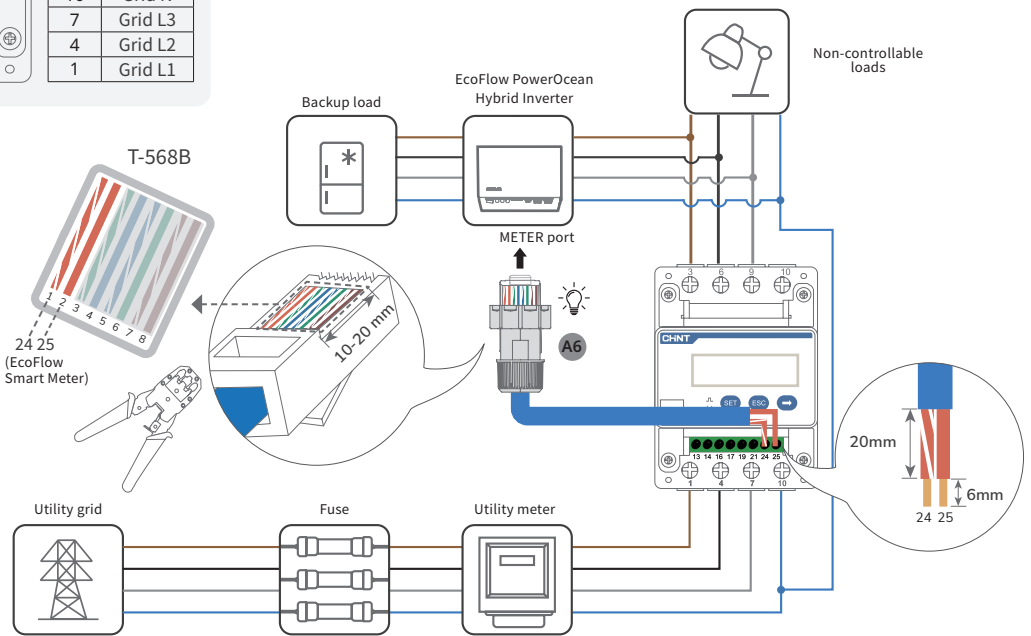

Connecting to Internet

NOTICE

- Use shielded CAT 5 or higher rating network cable for stable connection.

• METHOD 1: VIA A WIRED NETWORK

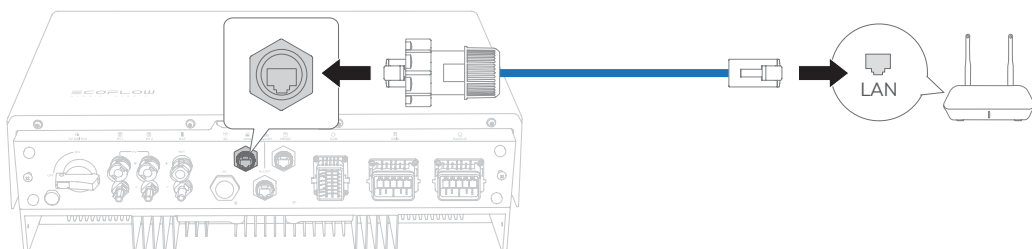

1   x1

For assembling a communication terminal, see **Connecting Battery Communication Cables** section.

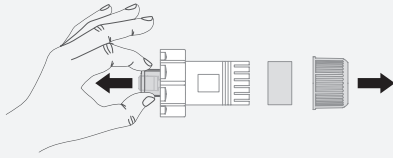

2 Both ends of the network cable use the T568B wiring standard.

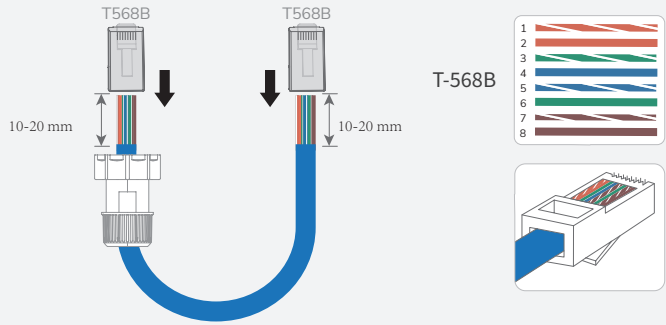

3 Test network cable connection. If the LEDs of the two RJ45 ports light up in sequence, it indicates that the network cable is correctly wired and should be fully operational.

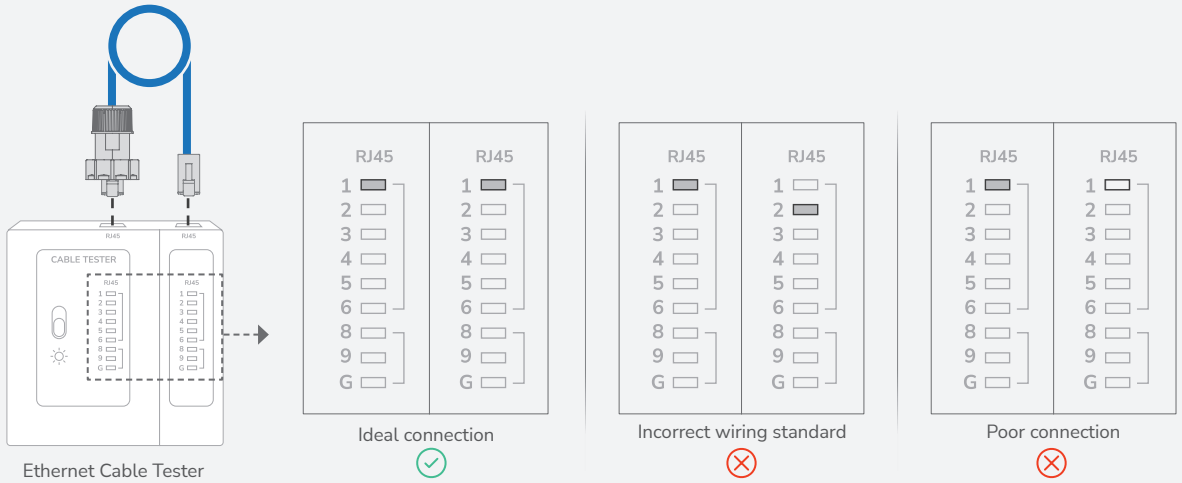

• METHOD 2: VIA A WIRELESS NETWORK

Adjust the Wi-Fi antenna, then refer to the System Commissioning section in this guide to connect to a wireless network.

INSTALL TRIM COVER ON THE BATTERY JUNCTION BOX AND INVERTER

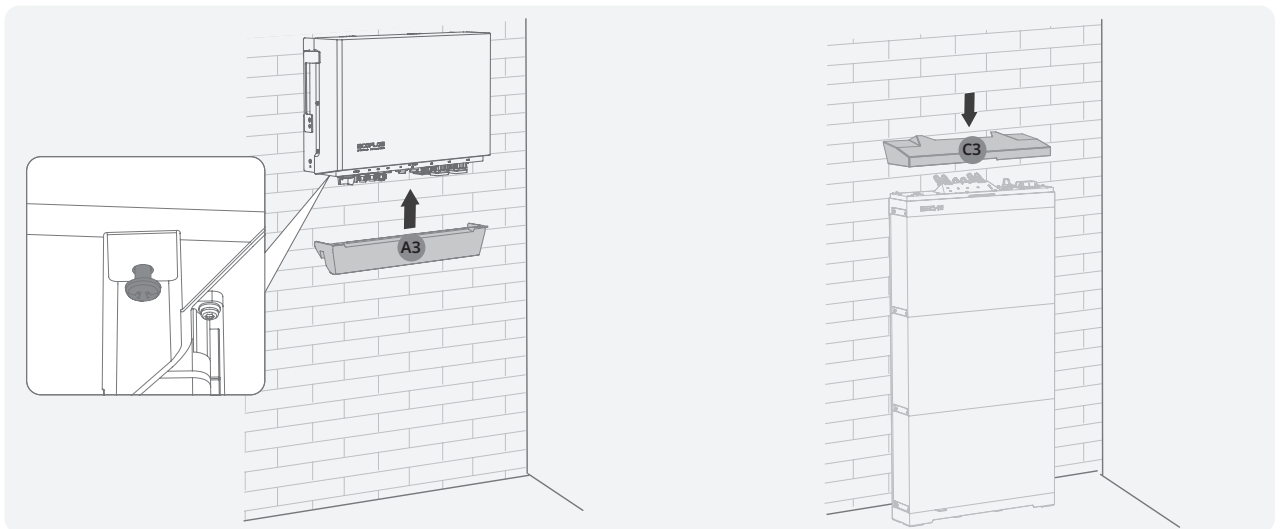

System Commissioning

Checking before Power-On

Check Item	Acceptance criteria
Equipments	Equipments are installed correctly and securely.
Cables routing	Cables are routed properly as required by the customer.
Cable tie	Cable ties are evenly distributed and no burr exists.
Grounding	The PE cable is connected correctly, securely, and reliably.
Switch	All the switches connecting to the system are OFF.
Cable connection	The AC/DC power cable, battery cable, and communication cable are connected correctly, securely, and reliably.
Unused terminal and port	Unused terminals and ports are locked by watertight covers.
Installation environment	The installation space is proper, and the installation environment is clean and tidy.

System Power-On

PROCEDURE (ON-GRID AND PV MODULE CONFIGURED)

1. Set the BATTERY SWITCH on top of the Junction Box to ON position.
2. Turn on the AC switch between the inverter and the power grid.
3. Set the PV SWITCH at the bottom of the inverter to ON position.
4. Observe the LED to check the inverter operating status.

PROCEDURE (OFF-GRID AND NO PV MODULE CONFIGURED)

1. Set the BATTERY SWITCH on top of the Junction Box to ON position.
2. Turn on the AC switch between the inverter and the power grid.
3. Set the PV SWITCH at the bottom of the inverter to ON position.
4. After commissioning, press and hold for three seconds the BATTERY ON/OFF button on top of the battery junction box.
5. Observe the LED to check the inverter operating status.

System Power-Off

Before installing, operating, and maintaining the equipment, always disconnect it from all power.



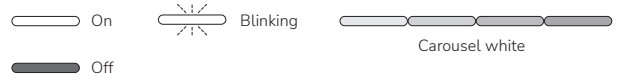

WARNING

- After the system powers off, the remaining electricity and heat may still cause electric shocks and body burns. Therefore, put on protective gloves and begin operating the equipment five minutes after the power-off.
1. Send a shutdown command on the App.
 2. Turn off the AC switch between the inverter and the power grid.
 3. Set the PV SWITCH at the bottom of the inverter to OFF position.
 4. (Optional) Secure the PV SWITCH with a lock to prevent accidental startup. The lock is prepared by the customer.
 5. Set the BATTERY SWITCH on top of the Junction Box to OFF position.
 6. (Optional) Secure the BATTERY SWITCH with a lock to prevent accidental startup. The lock is prepared by the customer.
 7. Press and hold the BATTERY ON/OFF button of the junction box for 10 seconds, until the indicator is off.
 8. Sequentially disconnect GRID cables, PV input cables, battery cables, communication cables and all modules connecting to the system.





LED Indicators





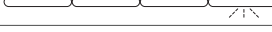

ECOFLOW POWEROCEAN HYBRID INVERTER

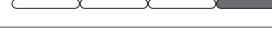
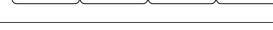

Status	Description
 on 1s  off 1s	Standby / Startup / Self-check / Over-the-air updates / Alarm, system is still operating
	Operating in grid-tied/backup mode
	EPO shutdown / Fault, system cannot work

ECOFLOW POWEROCEAN BATTERY JUNCTION BOX

Charge Status	Description
	0-25%
	25-50%
	50-75%
	75-99%
	100%

Discharge Status	Description
	<5%
	5-25%
	25-50%
	50-75%
	75-100%

Over-the-air Updates Status	Description
	Over-the-air update is in progress

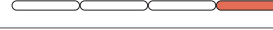
Faulty Status	Description
	Electrical connection is faulty
	Communication is faulty
	Battery is faulty
	Battery junction box is faulty

1 DOWNLOAD AND INSTALL ECOFLOW PRO APP (FOR INSTALLER ONLY)

Scan the QR code or download at:
<https://download.ecoflow.com/ecoflowproapp>



2 CREATE ACCOUNT

a. Create company account

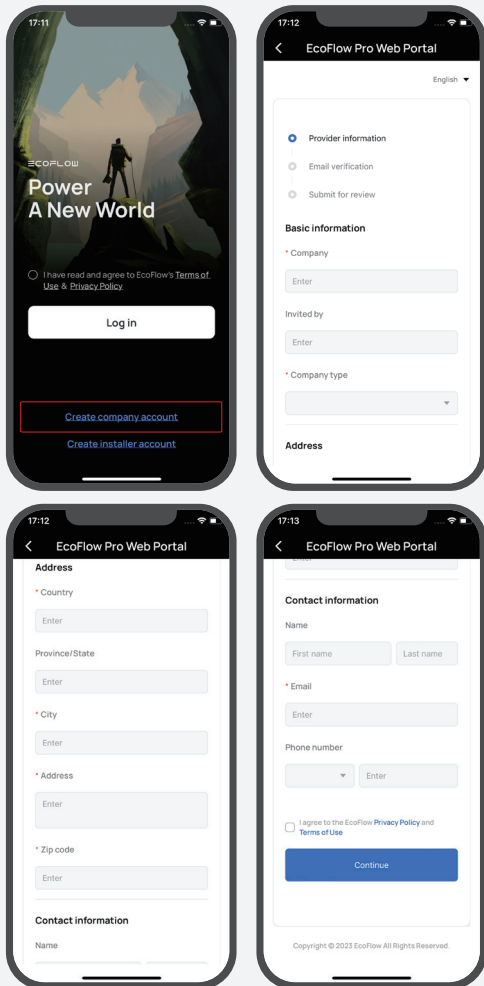

b. Create installer account

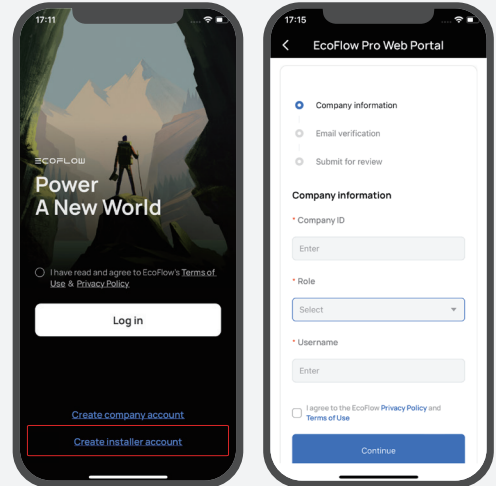

3 LOG IN

Enter the installer account and password.

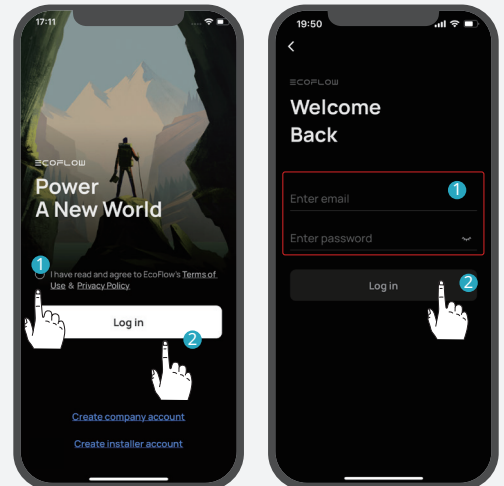

4 ADD DEVICE

You can connect to the system via Bluetooth or Wi-Fi.

a. Connect to the system via Bluetooth.

Click **Add System** to automatically search for bluetooth devices nearby, and click **EcoFlow PowerOcean** to connect, then click **Complete** to proceed.

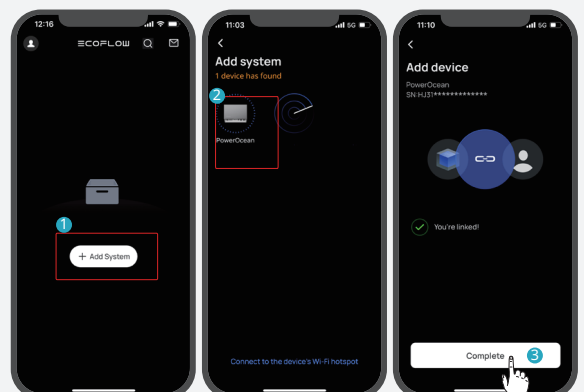

b. Connect to the system via Wi-Fi

1. Click "Add System" or "+" on the top right corner and then click "Or connect to the system's Wi-Fi" to access to your phone's Wi-Fi settings.
2. Find "PowerOcean_XXXX" and click it to enter the password for the Wifi, then click "Join". The password is the last 8 digits of the serial number of the inverter.

💡 You can find the serial number (S/N) in the product nameplate.

3. After successfully connected your phone to "PowerOcean_XXXX", tap the "EcoFlow Pro" on the top left of your phone's Wi-Fi setting page to shift back and proceed to commissioning.

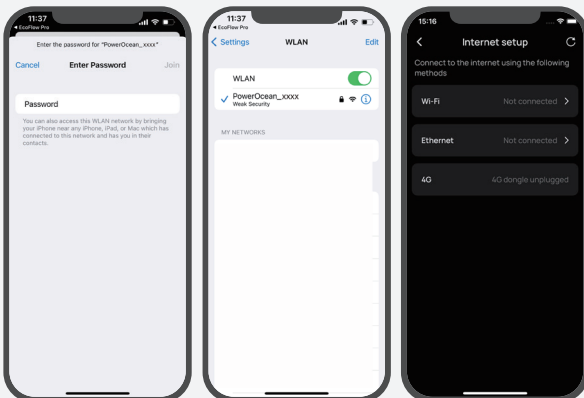
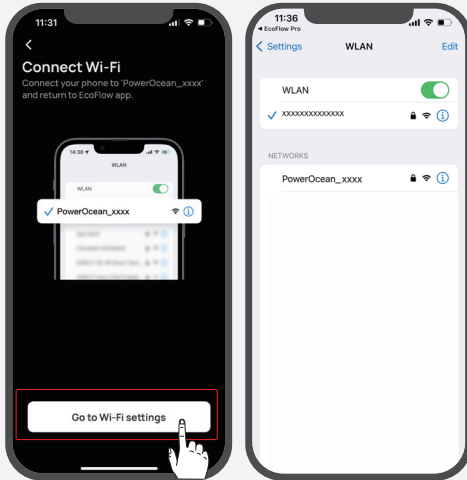
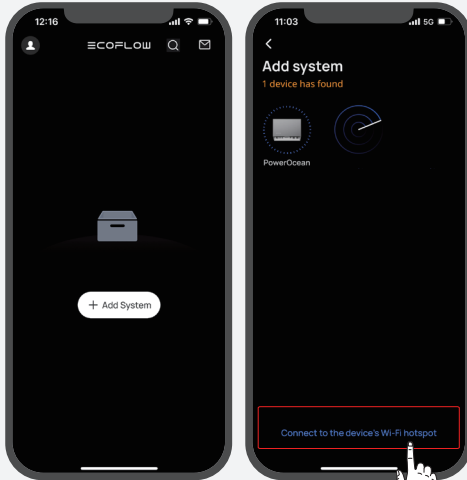

(Optional) Inverter cascading

1. Click "Have more than one PowerOcean? Try inverter cascading" to setup one of them as the primary inverter, the other one will be the secondary inverter by default. Prefer the inverter as the primary inverter with strong network signal.
If the current firmware of both inverters to be cascaded don't support cascading, you need to add them to the App and update their firmware before proceeding.
2. Verify the information of the inverters that need to be cascaded, then click "Next" to proceed to commissioning.

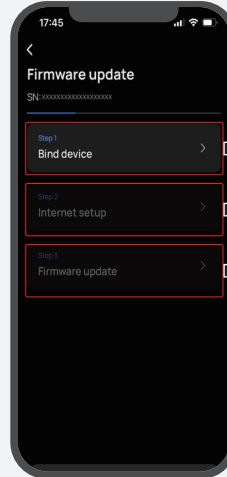
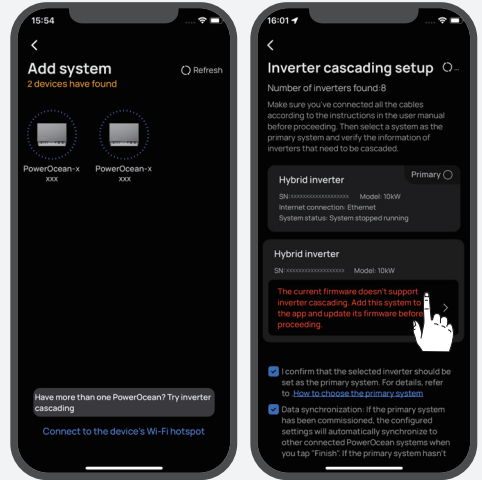

1. See "Add device" section of System Commissioning.
2. See "Internet setup" section of System Commissioning.
3. See "Device setting" section of System Commissioning.

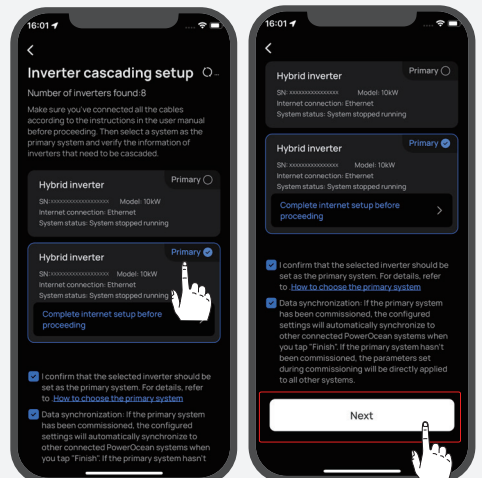

COMMISSIONING

After bound device successfully, the device enters the four-step commissioning process.

Step1: Internet Setup

click **Internet Setup** to start the network configuration.

Method 1: Wi-Fi

Click **WiFi**, select the appropriate WiFi name and enter the password and click **continue**.

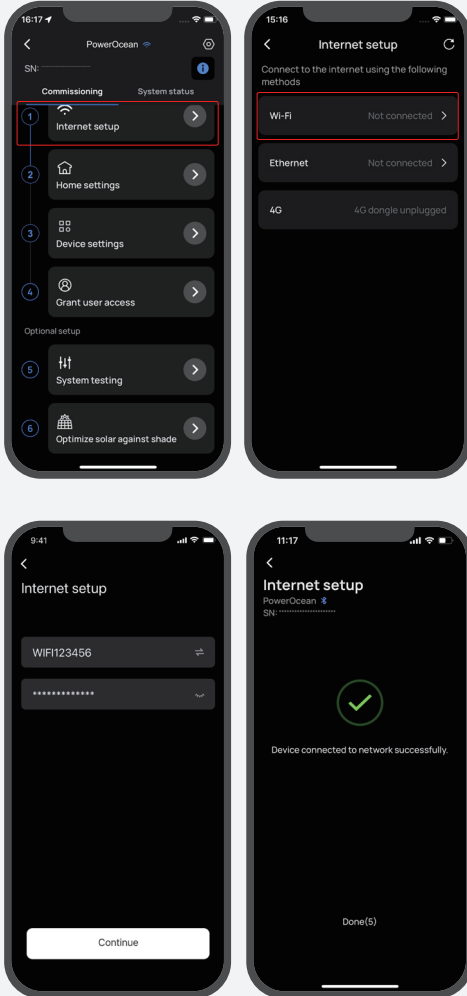

Method 2: Ethernet

Connect the system to a router using a network cable, wait a minute before proceeding. Then click "Ethernet" to set DHCP/Static mode. (Both modes are available)



- By default, the IP setting is DHCP mode, which assigns dynamic IP address to the device (recommended).
- Static mode requires manual configuration of the IP address. Please make sure the IP address is not in conflict with other devices, you can visit the router to check the IP addresses of other devices.

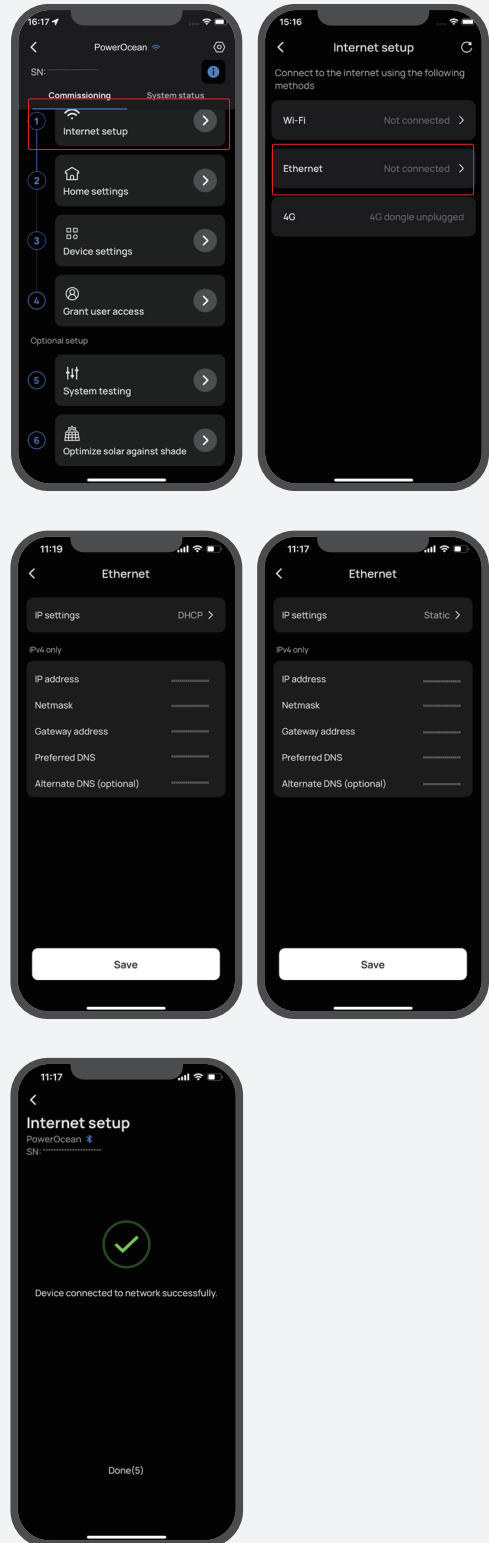

Method 3: 4G

1. Install a nano SIM card to the EcoFlow 4G Dongle ESS(EU).
2. Install the dongle onto the USB port (4G) of the inverter.
3. Activate your SIM card through App.



For more details about EcoFlow 4G Dongle ESS(EU), please refer to the user manual that comes together with.

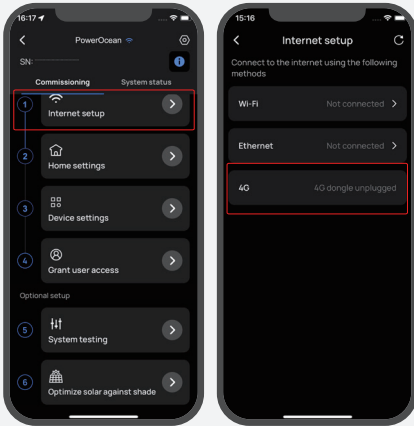

Step2: Home Setting

Click **Home Setting** to enter the corresponding house address.

(Optional) Set the electricity rate.

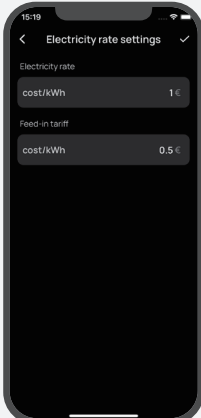
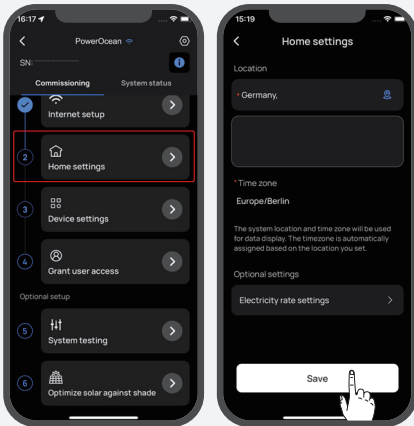

Step3: Device Setting

a. Click **Device Setting** to verify that the devices in the device list match the connected devices.

(Optional) Update firmware before carrying out Device Setting.

If there is a firmware update available for the EcoFlow PowerOcean system, the update page will pop up to notify you when proceeding this step. The "Skip" button is available for some update that is not urgent. It is highly recommended that you upgrade your PowerOcean firmware for seamless experience immediately.

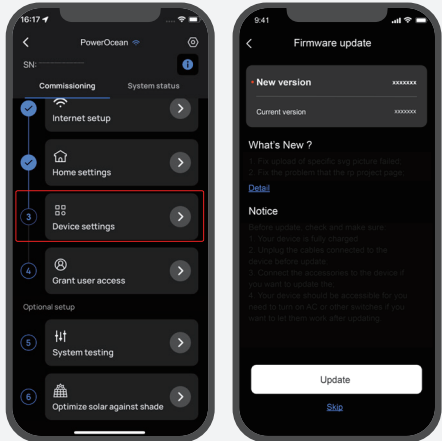

System check before carrying out Device Setting.

During the initial commissioning, there is a system check available for the EcoFlow PowerOcean system, allowing you to confirm all the system connections are correct.

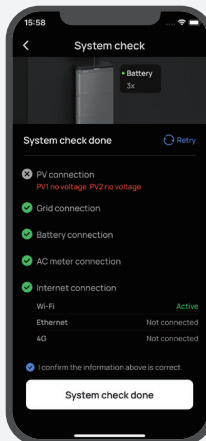

- b. Set grid code, system work mode and feed-in power limitation.
- c. (Optional) You can also tap **Customize Settings** to set Connection parameters, Voltage Protection parameters, Frequency Protection parameters, Reactive Power parameters and other parameters. (Please follow local regulations, if you need to change any of these parameters, please contact your local power organization first.)
- d. Click **Done** to finish the commissioning.

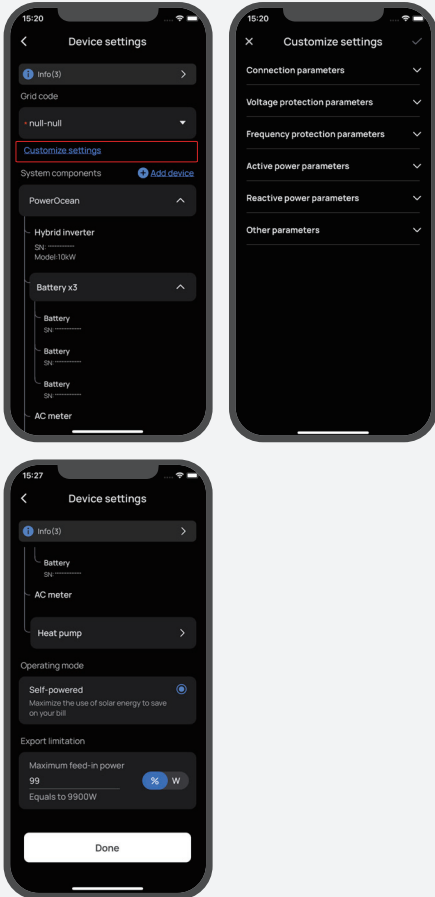

6

GRANT USER ACCESS

Click **Grant User Access** for a home owner access QR code to allow users to scan it.



- After manually adding device **EcoFlow PowerOcean** using the EcoFlow User App, users scan the home owner access QR code to bind it.

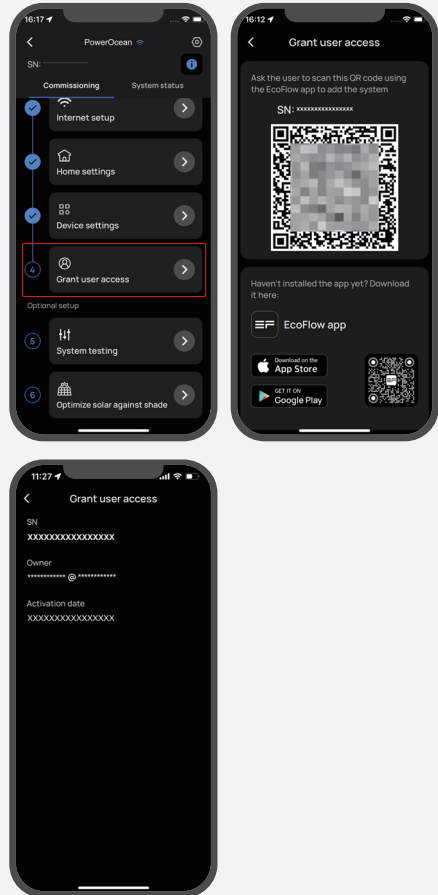

7

(OPTIONAL) SYSTEM TESTING

To test the go off-grid feature, you can toggle the button to switch the connection status of the system.

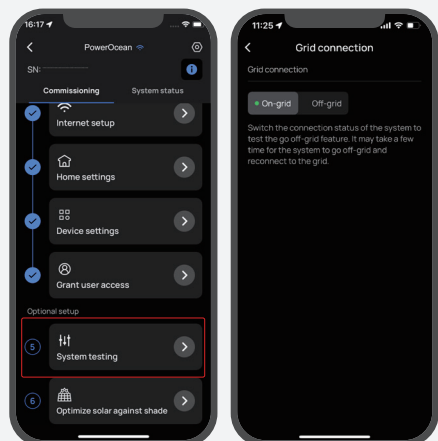

8

(OPTIONAL) OPTIMIZE SOLAR AGAINST SHADE

If this feature is enabled, the system will optimize solar generation in shaded conditions at your setup intervals to track the maximum power point. Solar generation may fluctuate.

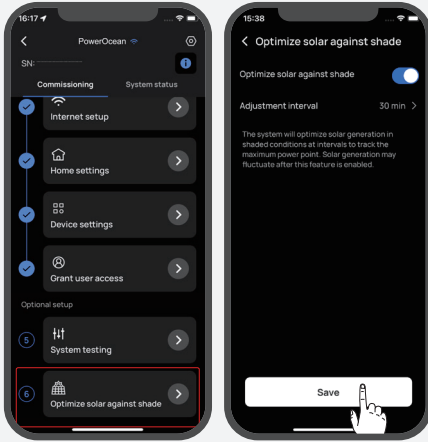

(OPTIONAL) ADD DEVICE TO THE SYSTEM

(Optional) Tap "Add Device" to integrate devices into this system, such as SG READY certified Heat Pump or charging pile etc., and setup relevant parameters.

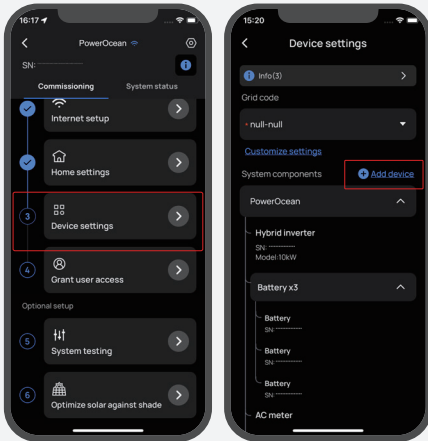

How Users Add Devices

1. DOWN AND INSTALL ECOFLOW USER APP (FOR USER ONLY)

Scan the QR code or download at: <https://download.ecoflow.com/app>

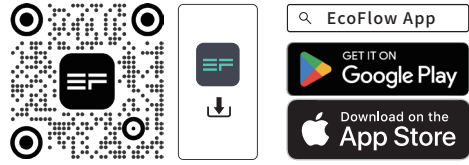

2. CREATE NEW ACCOUNT AND LOG IN.

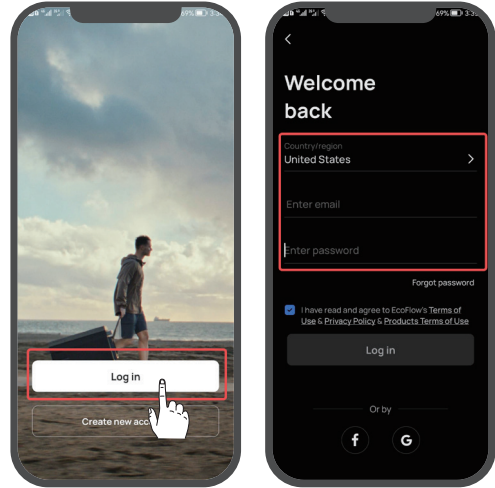

3. ADD DEVICE MANUALLY.

